



FIND A KAR DISTRIBUTOR IN YOUR AREA

<https://kar.ca/storelocator>



Small Tool Instruments and Data Management

Form Measurement

Digital Scales and DRO Systems

Sensor Systems

Test Equipment

Optical Measurement

SPRING PROMO 2025

PRECISION TOOLS & INSTRUMENTS



Effective April 1st through June 30th

SPRING PROMO 2025



NEW Products **NEW FEATURED PRODUCTS**



Dear Valued Customers,

I want to take a moment to express my sincere appreciation for your continued support and commitment to Mitutoyo products and services. The 2025 Mitutoyo Spring Promotion features many great Mitutoyo precision measurement instruments such as the recently updated QuantuMike digital micrometer, a wide variety of Surftest surface roughness instruments, new IDC/IDF indicators with S1 Digimatic output capabilities, test indicators, profile projectors, and the very popular redesigned LH-600F Linear Height Gage. The spring promotion also features many other trusted Mitutoyo tools and instruments including data management solutions, calipers, micrometers, linear encoders, test indicators, height gages, microscopes, hardness testers, and contact sensors such as linear gages and the motorized Litematic contact gage. Prices are effective April 1, 2025 through June 30, 2025.

You can find all of the latest promotions, products and events on our website, www.mitutoyo.ca. Thank you for trusting Mitutoyo with your metrology needs.

Sincerely,

Matt Dye
President, Mitutoyo America Corporation
and Mitutoyo Canada

Matthew B. Dye



TABLE OF CONTENTS

NEW Products	MDE QuantuMike 3	QuantuMike..... 3
	The new MDE QuantuMike delivers faster measurements - up to 4x faster than standard micrometers - with exceptional accuracy ($\pm 1 \mu\text{m}$ permissible error), an IP65 protection rating, and a user-friendly design with enhanced display.	Surftest SJ-220 Packages 4
NEW Products	Surftest SJ-220 4	Tool Kits 6
	Highly versatile surface roughness instruments, including portable models, are full of features and capabilities. Mitutoyo surface roughness testers deliver precise and accurate measurements.	Indicators 8
NEW Products	ID-C/ID-F Digimatic Indicators 8	Dial Test Indicators 9
	These new Digimatic Indicators have higher resolutions down to $20\mu\text{inch}/0.5 \mu\text{m}$, a built-in calibration date warning and analog bar on the larger LCD display, and new S1 Digimatic output capabilities.	Bore Gages 12
NEW Products	Dial Test Indicators 12	Holtest 13
	Mitutoyo test indicators provide enhanced durability, sensitivity, usability, readability, and most importantly, incredible accuracy. Mitutoyo offers a range of different types of test indicators along with accessories and sets for any application and industry.	Borematic 15
NEW Products	Profile Projectors 16	Profile Projectors 16
	Mitutoyo profile projectors provide some of the most accurate and clear images on the market. Easily capture accurate measurements without blurring, distortion or complex calculations using our modular 2D digital readouts.	Quick Image..... 18
NEW Products	LH-600F Linear Height Gages 20	LH-600F Height Gage..... 20
	The Mitutoyo LH-600F Linear Height Gage is the latest model in the Mitutoyo Linear Height Gage line with several new features like an adjustable and rotatable display, intuitive touchscreen interface, and added output options for even easier, highly accurate 1D and 2D dimensional measurements.	QM Height Gage..... 22
		Calipers/Caliper Checker..... 24
		Micrometers 26
		U-WAVE Bluetooth® Wireless Data Transmitters 28
		U-WAVE Wireless Data Transmitters 29
		Litematic Units 30
		Linear Gages/EJ Counters 31
		Digimatic Scale Units 32
		Linear Encoders 33
		Hardness Testers 34
		Microscopes..... 38

QuantuMike

High-speed, high-accuracy micrometer measures 4x faster vs standard micrometers



DIGIMATIC S1 IP65



4x Faster 1µm Accuracy



New Features

- > GO/NO-GO icons: at-a-glance verification
- > Calibration date alerts: warning and due date alerts
- > Approach Speed Warning: reduce over-torquing
- > Calculation: auto-calculate corrections and more
- > S1 Digimatic output — send measurement to Excel or easily program features with software (ITPak 3.0 or MeasurLink®)
- > Auto power On/Off. Key customization

Continued Great Features

- > 4x faster spindle speed
- > Preset, Zero, Hold, Function Lock, Error display
- > 1-pc Ratchet Thimble + Speeder
- > Resolution: .00005" / 0.001mm
- > Accuracy: +/- .00005" / 0.001mm

Comparison of time needed to measure a 6-stepped workpiece (with one hand)

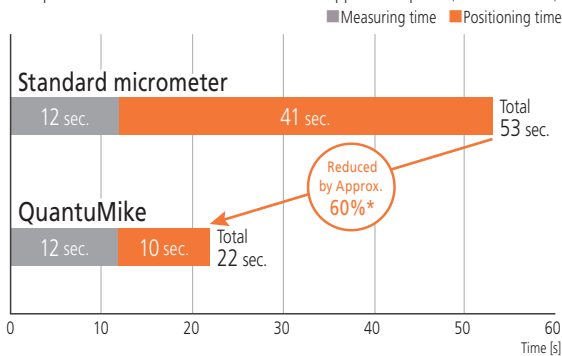

*According to Mitutoyo's comparison test data

GO/NG icons

Displays tolerance judgment mark
Tolerance judgment function: ON



Auto-calculate

Calculates and displays correction value
Calculation function: ON

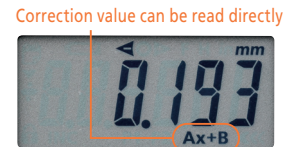

Correction value can be read directly
Customized key setting allows the user to easily switch between measurement values and calculation results with the press of a button.

Calibration alerts

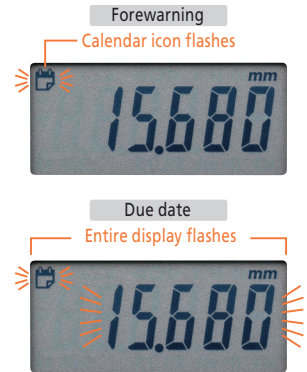

New S1 output — Send Measurement Wired or Wireless



Order No.	Description	List	Promo
293-180-40	QUANTUMIKE MICROMETER, DIGIMATIC, 0-1", IP65, .00005", W/SPC	\$406.25	\$385.94
293-181-40	QUANTUMIKE MICROMETER, DIGIMATIC, 1-2", IP65, .00005", W/SPC	\$465.00	\$441.75
293-182-40	QUANTUMIKE MICROMETER, DIGIMATIC, 2-3", IP65, .00005", W/SPC	\$554.00	\$526.30
293-183-40	QUANTUMIKE MICROMETER, DIGIMATIC, 3-4", IP65, .00005", W/SPC	\$605.00	\$574.75



SCAN ME

All prices are in Canadian Dollars

Versatility

Expand functionality by linking with a smartphone, etc.



Compatibility

Connectable and convenient. High-speed transmission of measurement data. Significantly strengthened communication functions.



USB communication for sending and receiving measurement data

Bidirectional communication is possible by connecting the SJ-220 to a PC with a USB cable and installing the dedicated app "SJ-Communication-Tool".

Measurement work can be made more efficient by setting measurement conditions on the PC.

*The USB connector also serves as a charging port.

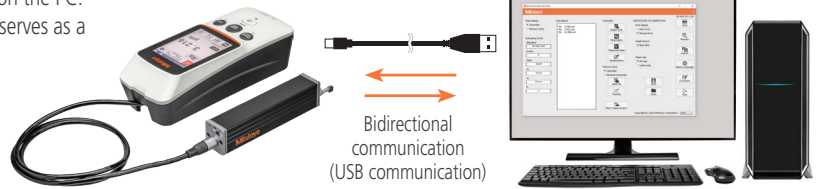

Dedicated app "SJ-App" for increased efficiency of measurement work

The dedicated app that enables communication with the SJ-220 is equipped with various functions to increase work efficiency. It is also possible to manage data, create inspection reports, and export to CSV and PDF files on the terminal.

Smartphone icon display

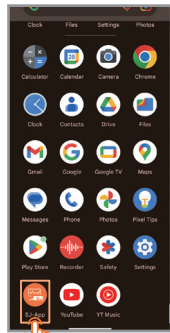

Startup screen



Calculation result

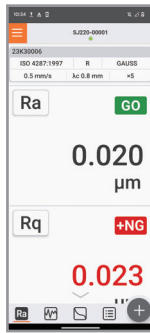

Inspection report

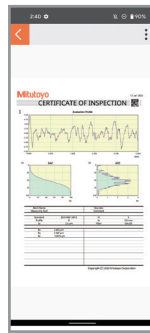

App



Dedicated smartphone app "SJ-App"

Freely available



Can be downloaded from the Mitutoyo website.
 ■ Download site URL
<https://www2.mitutoyo.co.jp/eng/contact/products/SJ-App/>
 Android 12 or later, Bluetooth® 5.0 compatible (Android only)

Added convenience by linking to PC with highly functional free software, "SJ-Communication-Tool"

We provide free software that allows you to import various data (measurement conditions, parameter settings, calculation results, measurement data) from the SJ-220 to create and edit inspection reports on your PC. This software can significantly reduce the time it takes to create reports.

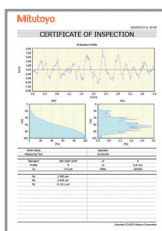
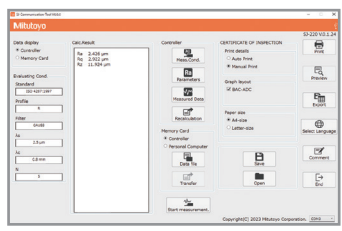

Confirmed operation environments
 ■ OS: Windows 10 (64 bit), Windows 11 (64 bit)
 * Windows is a product of Microsoft Corporation.
 * Connection requires a USB 2.0 Cable or a Wireless Unit for Measuring Instrument U-WAVE-TIB.

Software



PC-linked software "SJ-Communication-Tool"

Freely available



Can be downloaded from the Mitutoyo website.
 ■ Download site URL
<https://www2.mitutoyo.co.jp/eng/contact/products/SJ-Communication-Tool/>
 Windows 10/11, Bluetooth® 5.0 compatible (Windows only)

Surftest SJ-220 Packages

MeasurLink ENABLED
Data Management Software by Mitutoyo

- > NEW 2.8" color touch screen makes navigation and measuring condition settings easier to perform.
- > The built-in battery charges via USB Type-C has approximately 1,000 measurements on a full charge (4 hours charging time).
- > Performs roughness analysis conforming to international standards JIS '82 / JIS '94 / JIS '01 / ISO '97 / ANSI/VDI including ISO21920.
- > Optional MicroSD card can store up to 500 measurement conditions, 10,000 measurement results and 500 image data.
- > New [HOME] key lets the operator easily recall frequently used calibration and measurement conditions.



ASK US ABOUT OUR SJ-220 ELEARNING COURSE

Wireless connectivity now available for increased measurement data

Wireless Unit for Measuring Instrument U-WAVE-TIB
Bluetooth
(Bluetooth® 5.0)

Bidirectional communication (BLE communication)

Order No.	Description	List	Promo
178-741-13	Surftest SJ-220 Standard drive unit type 0.75mN inch	\$3,829.00	\$3,638.00
178-742-13	Surftest SJ-220 Standard drive unit type 4mN inch	\$3,829.00	\$3,638.00
178-744-13	Surftest SJ-220 R-Drive unit type 4mN inch	\$4,508.00	\$4,283.00
12AAA221	Adapter, Magnetic Stand, Dia. 8mm	\$65.00	\$48.75
178-069	Stand, SJ-210/310/410	\$1,456.00	\$1,412.00
178-390	Detector, Standard, 4MN, SJ	\$650.00	\$487.50
264-628	WIRELESS UNIT FOR MEASURING INST U-WAVE-TIB	\$410.00	\$390.00
12AAA233	Adapter, Height Gauge, 1/4" X 1/2"	\$147.00	\$125.00
570-413	Height Gauge, Digimatic, Absolute Linear Encoder 0-18", .0005" / 0-450mm, 0.01mm	\$1,383.00	\$1,313.85



12AAA233



12AAA233



12AAA221



178-390



570-413



178-069

All prices are in Canadian Dollars

**10%
OFF**

Soft Case Tool Kits

Durable Protective Cases

New protective cases for your tools offer a modern alternative to our wooden cases. Versions include mechanical, standard Digimatic, or QuantuMike-based sets. QuantuMikes are just as accurate as standard Digimatic micrometers, but up to 4x faster.

Empty cases are also available as a new home for your existing tools!



NEW
Products

64PKA288A



RUGGED, IMPACT-RESISTANT BUILD

**CASE MOULDS FOR DIGIMATIC
AND MECHANICAL TOOLS**

**LONG-LIFE ZIPPERS AND STAIN-
RESISTANT COVER**

**2X MAGNET-BACKED SLOTS FOR HOLDING STEEL
RULES, SPANNERS, THUMB DRIVES AND MORE**



Prices effective April 1 through June 30, 2025

All prices are in Canadian Dollars



64PKA283

Soft Case Tool Kit Components for 64PKA283

Part #	Description
103-135	MIC, OUTSIDE, 0-1", 0.0001", FRICTION THIMBLE
182-204	STEEL RULE 6" 3R FLEXIBLE
505-742J	DIAL CALIPER, 6", .1"/REV
64PMT183	CASE FOR MECHANICAL TOOL KIT



64PKA284

Soft Case Tool Kit Components for 64PKA284

Part #	Description
103-177	MIC, OUTSIDE, 0-1", 0.001", RATCHET STOP
182-102	STEEL RULE 6" 16R RIGID
505-740J	DIAL CALIPER, 6", .2"/REV
64PMT183	CASE FOR MECHANICAL TOOL KIT



64PKA285

Soft Case Tool Kit Components for 64PKA285

Part #	Description
293-340-30	1" RATCHET STOP MICROMETER (NO SPC)
500-196-30	DIGIMATIC CALIPER, 6"/150MM, NO OUTPUT
64PMT182	CASE FOR DIGIMATIC TOOL KIT



64PKA286

Soft Case Tool Kit Components for 64PKA286

Part #	Description
293-348-30	1" FRICTION THIMBLE MICROMETER (NO SPC)
500-196-30	DIGIMATIC CALIPER, 6"/150MM, NO OUTPUT
64PMT182	CASE FOR DIGIMATIC TOOL KIT



64PKA288A

Soft Case Tool Kit Components for 64PKA288A

Part #	Description
293-180-40	QUANTUMIKE MICROMETER, DIGIMATIC, 0-1", IP65, .00005", W/ SPC
500-171-30	DIGIMATIC CALIPER, 6"/150MM, W/ OUTPUT
64PMT182	CASE FOR DIGIMATIC TOOL KIT

Soft Case Tool Packages

Package #	Description	List	Promo
64PKA283	TOOL PKG, MECHANICAL, INCH, W/ 6" DIAL CALIPER, 1" OUTSIDE MIC, 6" STEEL RULE, CASE	\$444.00	\$399.60
64PKA284	TOOL PKG, MECHANICAL, INCH, W/ 6" DIAL CALIPER, 1" MIC, 6" STEEL RULE, CASE	\$375.00	\$337.50
64PKA285	TOOL PKG, DIGIMATIC, INCH, W/ 1" MIC (RATCHET STOP TYPE), 6" CALIPER, CASE	\$558.00	\$502.20
64PKA286	TOOL PKG, DIGIMATIC, INCH, W/ 1" MIC (FRICTION THIMBLE TYPE), 6" CALIPER, CASE	\$565.00	\$508.50
64PKA288A	TOOL PKG, DIGIMATIC, INCH, W/1" QUANTUMIKE, 6" CALIPER, CASE, WITH OUTPUT	\$739.25	\$665.33

Protective Case Only

Package #	Description	List	Promo
64PMT182	CASE FOR DIGIMATIC TOOL KIT	\$74.00	\$66.60
64PMT183	CASE FOR MECHANICAL TOOL KIT	\$77.00	\$69.30



SCAN ME

All prices are in Canadian Dollars

ID-C/ID-F Digimatic Indicators

High-performance ABS Digimatic Indicators

- > 20 µinch/0.5 µm resolution.
- > Large screen and analog bar.
- > Calibration period notification function. The LCD displays an icon to notify the user when the set calibration time approaches. This facilitates the proper precision management of ID-C/ID-F.
- > Simple Calculation Function.
- > New Digimatic S1 Output*. S1 is the new Mitutoyo bidirectional output format that enables reading and writing information to the gages such as sending a zero command, TIR reset, calibration date warnings, and the ability to poll the serial number for smoother measurement operation. Communication is supported by the new Input Tool and SPC cable, see table below.

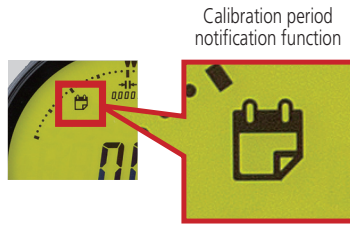

Calibration period notification function



0.5" ID-F MODEL NOW AVAILABLE



ID-C Series



ID-F Series

Large screen and analog bar

The units have large screens that can display various information in an easy-to-read manner. They also have an analog bar, convenient for observing subtle movements such as the approach to tolerance.

Order No.	Description	List
06AGL011	SPC DIGIMATIC Cable, TYPE S1 (1M)	\$98.00
264-020	USB INPUT TOOL	\$285.00

* SPC Cable and Input Tool are both required



Excel®
Send data directly into existing forms

ITPak 3.0 Freeware
Read/Write Data and set Parameters

MeasurLink® 10.4 (see page 29)
Data Management & SPC Software

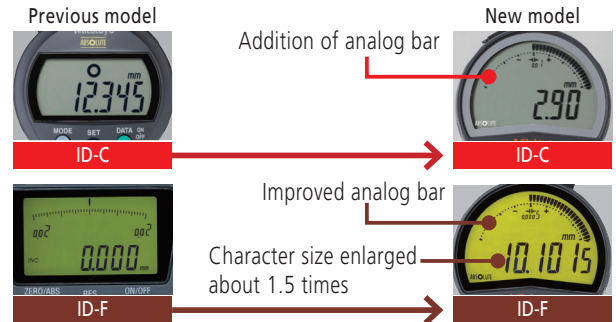

ID-C Series - Battery Operated

Order No.	With Lug	Flat Back	Range	Resolution	Maximum Permissible Error			Measuring for MPL (N)	Interface	Net mass (g)		List	Promo
					MPE _E	Hysteresis MPE _H	Repeatability MPE _R			With Lug	Flat Back		
543-702	543-702B	0.5" / 12.7mm	0.00002" / .00005" / 0.0001" / 0.0005" / 0.0005mm / 0.001mm / 0.01mm	± 0.00012" / 0.002mm	0.00008" / 0.002mm	0.00008" / 0.002mm	1.5 or less	d1/d2/S1	195	165	\$626.25	\$563.63	
543-707	543-707B	0.5" / 12.7mm					0.4 to 0.7	d1/d2/S1	190	160	\$939.00	\$845.10	
-	543-722B	1" / 25.4mm		1.8 or less			d1/d2/S1	-	195	\$671.00	\$603.90		
-	543-732B	2" / 50.8mm		2.3 or less			d1/d2/S1	-	260	\$1,050.00	\$945.00		
543-712	543-712B	0.5" / 12.7mm	0.0005" / 0.01mm	± 0.001" / 0.02mm	0.001" / 0.02mm	0.0005" / 0.01mm	0.9 or less	d1/S1	190	160	\$438.00	\$394.20	
543-717	543-717B	0.5" / 12.7mm					0.2 to 0.5	d1/S1	185	155	\$613.00	\$551.70	
-	543-727B	1" / 25.4mm		1.8 or less			d1/S1	-	190	\$671.00	\$603.90		
-	543-737B	2" / 50.8mm		± 0.0015" / 0.04mm			2.3 or less	d1/S1	-	245	\$880.00	\$792.00	

ID-F Series - AC Powered - Green/Red Backlit Display

Order No.	With Lug	Flat Back	Range	Resolution	Maximum Permissible Error			Measuring for MPL (N)	Interface	List	Promo
					MPE _E	Hysteresis MPE _H	Repeatability MPE _R				
543-856-A	543-856B-A	0.5" / 12.7mm	0.005mm / 0.001mm / 0.01 mm / 0.00002" / .00005" / 0.0001" / 0.0005" / 0.001" (selectable)	± 0.0001" / 0.0025mm	0.00008" / 0.002mm	0.00008" / 0.002mm	1.5 or less	d1/d2/S1	\$675.00	\$607.50	
-	543-852A	1" / 25.4mm					1.8 or less	d1/d2/S1	\$1,008.00	\$978.00	
-	543-854A	2" / 50.8mm		± 0.00016" / 0.004mm			2.3 or less	d1/d2/S1	\$1,147.00	\$1,090.00	
-	543-858A			± 0.00012" / 0.003mm			2.3 or less	d1/d2/S1	\$1,095.00	\$1,062.00	



All prices are in Canadian Dollars

Dial Test Indicators



.000050" / 50µinch model now available!

- > One-piece movement assembly for improved durability & impact resistance.
- > Contact point length shown on dial face.
- > Certificate of Inspection included.
- > Shows results from both measuring directions.
- > Resilient crystal with high resistance to glare, scratches and impact.



Contact point length is printed on dial face to avoid accuracy issues

Part #	Range	Graduations	Set Type	Face Color	List	Promo	Remarks
Standard							
513-407-10E	.008"	.00005"	Basic	White	\$264.00	\$237.60	Fine grads
513-407-10T	.008"	.00005"	Full	White	\$310.00	\$279.00	Fine grads
513-401-10E	.14mm	0.001mm	Basic	Yellow	\$314.00	\$282.60	
513-402-10E	.03"	.0005"	Basic	White	\$173.00	\$155.70	
513-402-10T	.03"	.0005"	Full	White	\$194.00	\$174.60	
513-403-10E	.008"	.0001"	Basic	White	\$201.00	\$180.90	
513-403-10T	.008"	.0001"	Full	White	\$281.00	\$252.90	
513-404-10E	0.8mm	0.01mm	Basic	Yellow	\$187.00	\$168.30	
513-404-10A	0.8mm	0.01mm	Plus	Yellow	\$206.00	\$185.40	
513-404-10T	0.8mm	0.01mm	Full	Yellow	\$220.00	\$198.00	
513-405-10E	0.2mm	0.002mm	Basic	Yellow	\$208.00	\$187.20	
513-405-10T	0.2mm	0.002mm	Full	Yellow	\$271.00	\$243.90	
513-406-10E	.03"/0.7mm	.0005"/0.01mm	Basic	White/Yellow	\$216.00	\$194.40	Dual dial
513-406-10T	.03"/0.7mm	.0005"/0.01mm	Full	White/Yellow	\$239.00	\$215.10	Dual dial
513-409-10E	0.2mm/.0076"	0.002mm/.0001"	Basic	Yellow/White	\$277.00	\$249.30	Dual dial
513-409-10T	0.2mm/.0076"	0.002mm/.0001"	Full	Yellow/White	\$282.00	\$253.80	Dual dial
513-412-10E	.03"	.0005"	Basic	White	\$264.00	\$237.60	
513-412-10T	.03"	.0005"	Full	White	\$304.00	\$273.60	
513-415-10E	1.0mm	0.01mm	Basic	Yellow	\$199.00	\$179.10	Long stylus
513-415-10H	1.0mm	0.01mm	Basic	Yellow	\$217.00	\$195.30	Long stylus
Ruby Tip							
513-472-10E	.03"	.0005"	Basic	White	\$206.00	\$185.40	
513-479-10E	.03"	.0005"	Basic	White	\$217.00	\$195.30	Long stylus
Standard (20° tilted face)							
513-442-10A	.06"	.0005"	Basic	White	\$249.00	\$224.10	
513-442-10T	.06"	.0005"	Full	White	\$282.00	\$253.80	
513-442-16A	.06"	.0005"	Basic	Black	\$249.00	\$224.10	
513-442-16T	.06"	.0005"	Full	Black	\$282.00	\$253.80	
513-446-16A	.06"	.0005"	Basic	Black	\$333.00	\$299.70	Long stylus
513-446-16T	.06"	.0005"	Full	Black	\$376.00	\$338.40	Long stylus
513-446-10A	.06"	.0005"	Basic	White	\$333.00	\$299.70	Long stylus
513-446-10T	.06"	.0005"	Full	White	\$376.00	\$338.40	Long stylus
513-443-10A	.016"	.0001"	Basic	White	\$314.00	\$282.60	
513-443-10T	.016"	.0001"	Full	White	\$356.00	\$320.40	
Vertical: dial is on the top of the frame							
513-452-10E	.03"	.0005"	Basic	White	\$238.00	\$214.20	
513-452-10T	.03"	.0005"	Full	White	\$264.00	\$237.60	
513-453-10E	.008"	.0001"	Basic	White	\$284.00	\$255.60	
Parallel: dial is on the side of the frame							
513-485-10E	0.2mm	0.002mm	Basic	Yellow	\$304.00	\$273.60	

Set Configuration

Inch

Full set

- Contact point, .039" DIA. carbide
- Contact point, .118" DIA. carbide
- Stem, .157" DIA. (21CAB106)
- Swivel clamp (900322, for .157" DIA., 3/8" DIA., dovetail)
- Inch holding bar (L: 4") (900306)

Basic set

- Contact point, .079" DIA. (Carbide)
- Indicator
- Knurled clamp ring
- Stem, .157" DIA. (21CAB106)
- Stem, 3/8" DIA.

Metric

Full set

- Swivel clamp (900321, for ø4mm, ø8mm, dovetail)
- Metric holding bar (L: 100mm) (900209)

Plus set

- Contact point, ø1mm carbide
- Contact point, ø3mm carbide
- Stem, ø4mm (21CAB106)

Basic set

- Contact point, ø2mm (Carbide)
- Indicator
- Knurled clamp ring
- Stem, ø8mm (Set No. 902804)

Labels: T set, E, A set, A set, C set (ø 6 Stem), E set, H set (ø 6 Stem)

All prices are in Canadian Dollars

Calculation-Type Digimatic Indicator ID-C

- Calculation-type Digimatic Indicator features both a key lock and parameter lock.
- Fast measurement frequency up to 50 per second.
- An analog bar provides easy-to-read values when scanning for Max, Min and TIR Values.
- Improved parameter setting software makes it even easier to set all of the available parameters to determine and upload the proper coefficients for calculation. (optional) 21EZA313
- The ABSOLUTE Digimatic indicator performs internal calculations using the formula $Ax+B+Cx-1$ (assuming spindle displacement as x), while the specified

coefficients A, B and C can be set with respect to the purpose of measurement or dimensions of the fixtures. This unique feature allows for reading measurements directly without searching for conversions.



Custom fixture shown

SPC ABSOLUTE

MeasurLink ENABLED
Data Management Software by Mitutoyo

10% OFF



543-342B-10

Order No.	Resolution	Range	Accuracy	Measuring Force	List	Promo
543-342B-10	.00005/.0001/.0005" (0.001/0.01mm) Selectable	.5"/12.7mm	±.00010"/0.003mm	1.5N or less	\$653.00	\$587.70

Stem dia. 3/8" #4-48 UNF Thread

SPC cable – 1m: 905338 2m: 905409

Bore Gage ABSOLUTE Digimatic Indicator ID-C



Installed on optional bore gage probe (page 12)

- Hold automatically picks up hole diameter after a sweep.
- Bore Gage Digimatic Indicator features both a key lock and parameter lock.
- Fast measurement frequency up to 50 per second.
- Analog bar provides easy-to-read values when scanning for Max, Min and TIR values.
- Up to three sets of master values and upper/lower tolerance values can be stored.

- GO/NO-GO judgment
- Employing the ABSOLUTE linear encoder, the ID-C always displays the spindle ABSOLUTE Position from the origin at power-on.
- Improved parameter setting software makes it even easier to set all of the available parameters to determine and upload the proper coefficients for calculation. (optional) 21EZA313

MeasurLink ENABLED
Data Management Software by Mitutoyo

10% OFF



543-312B-10

Order No.	Resolution	Range	Accuracy	Measuring Force	List	Promo
543-312B-10	.00005/.0001/.0005" (0.001/0.01mm) Selectable	.5"/12.7mm	±.00010"/0.003mm	1.5N or less	\$629.00	\$566.10

SPC cable – 1m: 905338 2m: 905409

SPC ABSOLUTE

Peak Hold ABSOLUTE Digimatic Indicator ID-C

With Max./Min. Value Holding Function

- Peak Hold Digimatic Indicator features both a Key Lock and Parameter Lock.
- An analog bar provides easy-to-read values when scanning for Max, Min and TIR Values.
- GO/NO-GO judgment
- The maximum, minimum or runout value can be displayed during measurement.

- Fast measurement frequency up to 50 per second.
- Employing the ABSOLUTE linear encoder, the Signal ID-C always displays the spindle ABSOLUTE Position from the origin at power-on.
- Improved parameter setting software makes it even easier to set all of the available parameters and then determine and upload the proper coefficients for calculation. (optional) 21EZA313

15% OFF



543-302B-10

Order No.	Resolution	Range	Accuracy	Remarks	List	Promo
Stem dia. 3/8", #4-48 UNF Thread						
543-302-10	.00005/.0001/.0005" 0.001/0.01mm	.5"/12.7mm	±.00010"/0.003mm	w/lug	\$629.00	\$534.65
543-302B-10	Selectable	.5"/12.7mm	±.00010"/0.003mm	Flat-back	\$629.00	\$534.65

SPC cable – 1m: 905338 2m: 905409

SPC ABSOLUTE

MeasurLink ENABLED
Data Management Software by Mitutoyo

Prices effective April 1 through June 30, 2025

Digimatic Indicator ID-H

Remote Programming Capable

- > This digital indicator offers excellent accuracy and functionality with an easy-to-read display. Take advantage of its high accuracy, backed up by 0.5µm / .00002" resolution, remote control functionality via a handheld controller (or an RS-232C interface) and easy runout measurements with the analog bar display.
- > With RS-232C input/output
- > The maximum, minimum or runout value can be displayed during measurement.
- > GO/NO-GO judgment is performed by setting the upper and lower tolerances. If a judgment result is out of tolerance, the display backlighting changes from green to red, so tolerance judgment can be made at a glance.

Stem dia. 3/8" #4-48 UNF Thread

Order No.	Resolution	Range	Model	Accuracy	List	Promo
543-562A	.00002", .00005", .0001", 0.0005mm, 0.001mm	1.2" / 30.4mm	ID-H530E	0.0015mm	\$1,250.00	\$1,125.00
543-564A		2.4" / 60.9mm	ID-H560E	0.0025mm	\$1,489.00	\$1,340.10

SPC cable – 1m: 936937 2m: 965014

10% OFF

SPC

MeasurLink ENABLED
Data Management Software by Mitutoyo

21EZA099
Remote controller
(optional)



ABSOLUTE Digimatic Indicator ID-S

- > Employing the ABSOLUTE linear encoder, the ID-S always displays the spindle ABSOLUTE Position from the origin at power-on. Also, unlimited response speed eliminates overspeed errors.
- > Dust/water protection level: IP42 (IP53: 543-796B-10).
- > SPC data output

SPC
ABSOLUTE

MeasurLink ENABLED
Data Management Software by Mitutoyo

10% OFF



Order No.	Resolution	Range	Accuracy	Measuring force	Remarks	List	Promo
Stem dia. 3/8", #4-48 UNF Thread							
543-792-10	.00005"/0.001mm	.5" / 12.7mm	±.0001"	1.5N or less	w/ lug back	\$388.00	\$349.20
543-796-10	.00005"/0.001mm	.5" / 12.7mm	±.0001"	2.5N or less	w/ lug-back	\$427.00	\$384.30
543-793-10	.0001"/0.001mm	.5" / 12.7mm	±.0001"	1.5N or less	w/ lug back	\$388.00	\$349.20
543-783-10	.0005"/0.01mm	.5" / 12.7mm	±.0010"	1.5N or less	w/ lug-back	\$250.00	\$225.00
543-792B-10	.00005"/0.001mm	.5" / 12.7mm	±.0001"	1.5N or less	w/ flat back	\$388.00	\$349.20
543-796B-10	.00005"/0.001mm	.5" / 12.7mm	±.0001"	2.5N or less	w/ flat-back	\$462.00	\$415.80
543-793B-10	.00005"/0.001mm	.5" / 12.7mm	±.0001"	1.5N or less	w/ flat back	\$388.00	\$349.20
543-783B-10	.0005"/0.01mm	.5" / 12.7mm	±.0010"	1.5N or less	w/ flat-back	\$209.00	\$188.10

ABSOLUTE Digimatic Indicator ID-U

- > Economical, Slim digital indicator.
- > Large LCD and simple key operation.
- > Ideal for installation into measuring devices because of its compact design and long battery life.
- > Employing the ABSOLUTE linear encoder, the ID-U always displays the spindle ABSOLUTE position from the origin at power-on. Also, unlimited response speed eliminates overspeed errors.
- > Long stem for mounting.

10% OFF



SPC
ABSOLUTE

MeasurLink ENABLED
Data Management Software by Mitutoyo

Order No.	Resolution	Range	Model	Accuracy	Measuring force	List	Promo
575-123	.0005"/0.01mm	1" / 25.4mm	ID-U1025E	.0008"	1.8N or less	\$276.00	\$248.40

SPC cable – 1m: 905338 2m: 905409

All prices are in Canadian Dollars

Series Two Dial Indicators

- › Improved impact- and oil-resistant materials are employed in the bezel. The improved shape of the crystal face helps with easier measurement readings.
- › High-strength, heat-treated stainless steel spindles for longevity.
- › Scratch- and chemical-resistant hard-coated crystals.
- › Increased rigidity in the bearing plate for reducing the retracing error (20%), and 4-screw mounting for greater impact resistance.
- › Inspection certificate included.
- › No through screw-holes on the frame for high oil- and dust-resistance. The bezel clamp (optional) can be attached either to the right or left side.



2803A-10



2424A-19

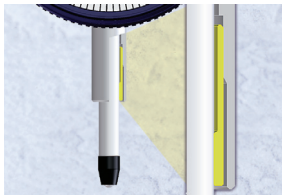

Revolutionary stem-bushing design for trouble-free stem clamping (longer clamping range; maximum tightening torque at the clamping point with M5 screw: 150N•cm).

Order No.	Graduation	Range	Range/Rev	Type	Dial Reading	Accuracy First 2.5 Rev/Overall	Force	List	Promo
2358A-10*	.0001"	.5"	.01"	w/lug	0-10	.0001 / .0008	2.0N or less	\$313.00	\$281.70
2803A-10*	.0001"	.025"	.01"	w/lug	0-5-0	.0001 / .0001	2.5N or less	\$227.00	\$204.30
2416A-10*	.001"	1"	.1"	w/lug	0-100	.001 / .002	1.8N or less	\$176.00	\$158.40
2424A-19*	.001"	2"	1"	w/lug	0-100	.001 / .003	2.5N or less	\$343.00	\$308.70
2776A	.0005"	1"	.05"	w/lug	0-50	.0005 / .002	2.5N or less	\$179.00	\$161.10

*Jeweled bearing model

Bore Gages

- › Carbide-tipped contact points for durability.
- › The dial indicator is fully protected by a rugged cover.
- › Optional extension rods can be attached for measuring deep holes.
- › The grip minimizes the variation of measurements by reducing heat transfer from the operator's hand.



511-751-20



Order No.	Range	Graduation	Anvils	Spacers	List	Promo
With Indicator						
511-751-20	.7 - 1.4"	.0001" (2923B-10)	9	2	\$524.00	\$471.60
511-752-20	1.4 - 2.5"		6	4	\$576.00	\$518.40
511-753-20	2.0 - 6.0"		11 (2" sub anvil)	4	\$565.00	\$508.50
511-754-20	4.0 - 6.5"		13	4	\$840.00	\$756.00
511-755-20	6.5 - 10"		6	7	\$925.00	\$832.50
511-756-20	10 - 16"		5 (3" sub anvil)	7	\$1,099.00	\$989.10
Without Indicator						
511-731	.7 - 1.4"	Indicator optional Protective Cover optional (21DZA000)	9	2	\$370.00	\$333.00
511-732	1.4 - 2.5"		6	4	\$380.00	\$342.00
511-733	2.0 - 6.0"		11 (2" sub anvil)	4	\$410.00	\$369.00
511-734	4.0 - 6.5"		13	4	\$613.00	\$551.70
511-735	6.5 - 10"		6	7	\$719.00	\$647.10
511-736	10 - 16"		5 (3" sub anvil)	7	\$903.00	\$812.70



See Digimatic indicators made specifically for bore gages (page 10).

Holtest

- > Titanium-coated measuring pins provide excellent durability and impact resistance while allowing the instrument to measure close to the bottom of blind holes.
- > Three-point design ensures self-centering action for stable measurements in the range above .275" bore diameter.
- > With ratchet stop for consistent force.

Holtest Type II

- > Holtest Type II models are also available. These lower-costs units have solid, hardened alloy steel anvils.

Mechanical Holtests – Individual Units

Order No.	Description/Range	List	Promo
368-021	Holtest, 0.08" - 0.1"	\$2,113.00	\$1,690.40
368-022	Holtest, 0.1" - 0.12"	\$2,113.00	\$1,690.40
368-023	Holtest, 0.12" - 0.16"	\$1,705.00	\$1,364.00
368-024	Holtest, 0.16" - 0.2"	\$1,705.00	\$1,364.00
368-025	Holtest, 0.2" - 0.24"	\$1,705.00	\$1,364.00
368-026	Holtest, 0.24" - 0.28"	\$1,705.00	\$1,364.00
368-261	Holtest, 0.275" - 0.35"	\$844.00	\$675.20
368-262	Holtest, 0.35" - 0.425"	\$844.00	\$675.20
368-263	Holtest, 0.425" - 0.5"	\$844.00	\$675.20
368-264	Holtest, 0.5" - 0.65"	\$874.00	\$699.20
368-265	Holtest, 0.65" - 0.8"	\$874.00	\$699.20
368-266	Holtest, 0.8" - 1.0"	\$909.00	\$727.20
368-267	Holtest, 1.0" - 1.2"	\$909.00	\$727.20
368-268	Holtest, 1.2" - 1.6"	\$1,135.00	\$908.00
368-269	Holtest, 1.6" - 2.0"	\$1,197.00	\$957.60
368-270	Holtest, 2.0" - 2.5"	\$1,204.00	\$963.20
368-271	Holtest, 2.5" - 3.0"	\$1,307.00	\$1,045.60
368-272	Holtest, 3.0" - 3.5"	\$1,343.00	\$1,074.40
368-273	Holtest, 3.5" - 4.0"	\$1,405.00	\$1,124.00
368-274	Holtest, 4.0" - 5.0"	\$1,803.00	\$1,442.40
368-275	Holtest, 5.0" - 6.0"	\$2,043.00	\$1,634.40
368-276	Holtest, 6.0" - 7.0"	\$2,099.00	\$1,679.20
368-277	Holtest, 7.0" - 8.0"	\$2,169.00	\$1,735.20
368-278	Holtest, 8.0" - 9.0"	\$2,465.00	\$1,972.00
368-279	Holtest, 9.0" - 10"	\$2,762.00	\$2,209.60
368-280	Holtest, 10" - 11"	\$2,789.00	\$2,231.20
368-281	Holtest, 11" - 12"	\$2,860.00	\$2,288.00

Mechanical Holtests – Complete Unit Sets

Order No.	Description/Range	List	Promo
368-916	Holtest, Set, 0.275" - 0.5"*	\$3,114.00	\$2,491.20
368-917	Holtest, Set, 0.5" - 0.8"*	\$2,099.00	\$1,679.20
368-918	Holtest, Set, 0.8" - 2.0"*	\$4,804.00	\$3,843.20
368-919	Holtest, Set, 2.0" - 4.0"*	\$6,847.00	\$5,477.60
368-920	Holtest, Set, 4.0" - 8.0"*	\$10,479.00	\$8,383.20
368-926	Holtest, 2pc Set, .08" - .12"*	\$4,493.00	\$3,594.40
368-927	Holtest, 4pc Set, .12" - .28"*	\$7,170.00	\$5,736.00

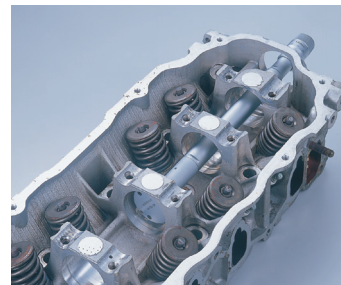
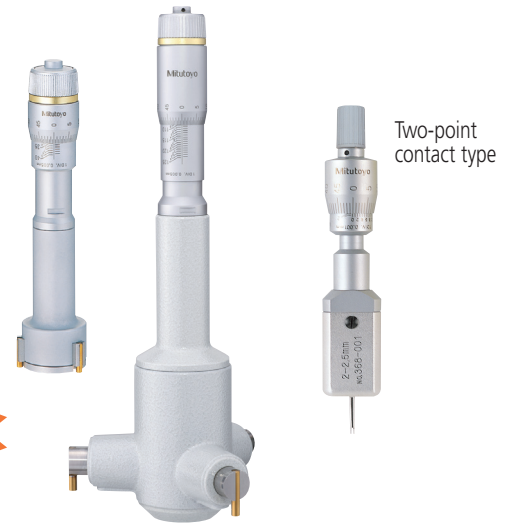

Measuring a Blind Hole

The measuring contact points held in the jaws permit measuring the diameter of a blind hole to the bottom. (up to 100mm / 4" models)

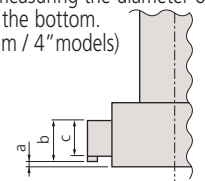

Range	a	b	c
6 - 12mm / .275 - .5"	2	—	2.5
12 - 20mm / .5 - .8"	0.3	5.6	3.5
20 - 30mm / .8 - 1.2"	0.3	8.3	5.2
30 - 50mm / 1.2 - 2"	0.3	13	10
50 - 100mm / 2 - 4"	0.3	17	14
100 - 300mm / 4 - 12"	12.4	21	13.8

Measuring Deep Holes

An extension tube (optional accessory) can be fitted to enable measurement of deep holes.



TiN coated contact points



Inspection Certificate Supplied as Standard

An Inspection Certificate is supplied with each instrument, which assures product quality and safety. On request, Mitutoyo can issue a Calibration Certificate, at a cost, from our accredited calibration laboratory.

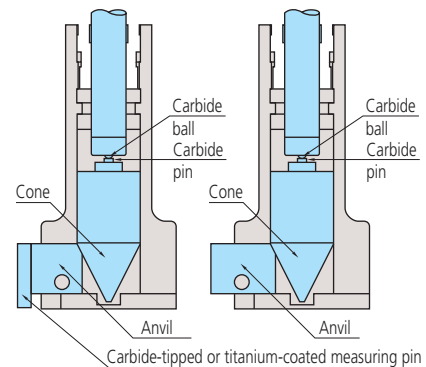

All prices are in Canadian Dollars

Digimatic Holtest

- > Titanium-coated measuring pins provide excellent durability and impact resistance while allowing the instrument to measure close to the bottom of blind holes.
- > Large LCD readout.
- > Functions available: Presetting, Zero/ABS, Auto power On/Off, Data hold, Data output, Error alarm, Battery replacement alarm.
- > With ratchet stop for consistent force.
- > Measure deep holes by attaching an extension rod (optional).
- > Setting rings are included in sets, but optional for individual gages.
- > Supplied in fitted plastic case up to 4"/100mm. Over 4"/100mm supplied in wooden case.
- > Resolution: .00005"/0.001mm (over 4" models: .0001"/0.001mm)

Digimatic Holtests – Individual Units

Order No.	Range	List	Promo
468-261	Digimatic Holtest, .275 - .35"	\$1,564.00	\$1,251.20
468-262	Digimatic Holtest, .35" - .425"	\$1,564.00	\$1,251.20
468-263	Digimatic Holtest, .425 - .5"	\$1,578.00	\$1,262.40
468-264	Digimatic Holtest, 0.5" - 0.65"	\$1,718.00	\$1,374.40
468-265	Digimatic Holtest, 0.65" - 0.8"	\$1,718.00	\$1,374.40
468-266	Digimatic Holtest, 0.8" - 1"	\$1,761.00	\$1,408.80
468-267	Digimatic Holtest, 1.0 - 1.2"	\$1,761.00	\$1,408.80
468-268	Digimatic Holtest, 1.2" - 1.6"	\$1,803.00	\$1,442.40
468-269	Digimatic Holtest, 1.6" - 2.0"	\$1,817.00	\$1,453.60
468-270	Digimatic Holtest, 2" - 2.5"	\$1,972.00	\$1,577.60
468-271	Digimatic Holtest, 2.5" - 3"	\$1,972.00	\$1,577.60
468-272	Digimatic Holtest, 3" - 3.5"	\$2,000.00	\$1,600.00
468-273	Digimatic Holtest, 3.5" - 4"	\$2,028.00	\$1,622.40
468-274	Digimatic Holtest, 4" - 5"	\$2,649.00	\$2,119.20
468-275	Digimatic Holtest, 5" - 6"	\$2,719.00	\$2,175.20
468-276	Digimatic Holtest, 6" - 7"	\$2,888.00	\$2,310.40
468-277	Digimatic Holtest, 7" - 8"	\$3,014.00	\$2,411.20
468-278	Digimatic Holtest, 8" - 9"	\$3,212.00	\$2,569.60
468-279	Digimatic Holtest, 9" - 10"	\$3,282.00	\$2,625.60
468-280	Digimatic Holtest, 10" - 11"	\$3,395.00	\$2,716.00
468-281	Digimatic Holtest, 11" - 12"	\$3,550.00	\$2,840.00

Digimatic Holtests – Interchangeable Head Sets

Order No.	Range	List	Promo
468-976	Digimatic Holtest Head Set, 0.275" - 0.5"*	\$2,860.00	\$2,288.00
468-977	Digimatic Holtest, Head Set, 0.5" - 0.8"*	\$2,324.00	\$1,859.20
468-978	Digimatic Holtest, Head Set, 0.8" - 2"*	\$5,617.00	\$4,493.60
468-979	Digimatic Holtest, Head Set, 2" - 4"*	\$6,649.00	\$5,319.20
468-980	Digimatic Holtest, Head Set, 4" - 8"*	\$7,804.00	\$6,243.20

Digimatic Holtests – Complete Unit Sets

Order No.	Range	List	Promo
468-986	Digimatic Holtest, Unit-Set, 0.275" - 0.5"*	\$5,579.00	\$4,463.20
468-987	Digimatic Holtest, Unit-Set, 0.5" - 1"*	\$5,917.00	\$4,733.60
468-988	Digimatic Holtest, Unit-Set, 1" - 2"*	\$6,706.00	\$5,364.80
468-989	Digimatic Holtest, Unit-Set, 2" - 3"*	\$7,352.00	\$5,881.60
468-990	Digimatic Holtest, Unit-Set, 3" - 4"*	\$7,606.00	\$6,084.80



MeasurLink ENABLED
Data Management Software by Mitutoyo



Measuring Deep Holes

An extension rod (optional accessory) can be fitted to provide measurement of deep holes.

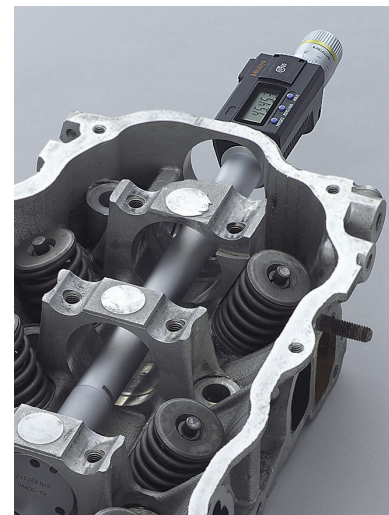

▶ SCAN ME



Complete-Unit Set



Interchangeable-Head Set

Prices effective April 1 through June 30, 2025

Borematic

Quick, spring-loaded lever action/movement

- > Titanium-coated measuring pins provide excellent durability and impact resistance while allowing the instrument to measure close to the bottom of blind holes.
- > Digital display with quick-action lever operation enables quick and easy measurement.
- > Built-in ABSOLUTE System eliminates the need to set the origin point every time the unit is turned on. The system is immune to over-speed errors, thus increasing the reliability of measurement.
- > The Digimatic Borematic is compatible with statistical process control systems and measurement support systems.
- > Built-in tolerance judgment function allows GO/NO-GO judgment based on user-defined upper and lower limit settings.

20% OFF



MeasurLink ENABLED
Data Management Software by Mitutoyo

ABSOLUTE

SPC

Individual Gages: includes one digital display unit and one interchangeable measuring head (plus adapter if required)

Order No	Size Range	Accuracy	Extension Rod	List	Promo
568-461	0.275" - 0.350"	±5µm ±0.00025 in	100mm (952322)	\$2,043.00	\$1,634.40
568-462	0.350" - 0.425"			\$2,043.00	\$1,634.40
568-463	0.425" - 0.500"			\$2,043.00	\$1,634.40
568-464	0.50" - 0.65"	±5µm ±0.00025 in	150mm (952621)	\$2,085.00	\$1,668.00
568-465	0.65" - 0.80"			\$2,039.00	\$1,631.20
568-466	0.8" - 1.0"	±6µm ±0.0003 in	150mm (952622)	\$2,085.00	\$1,668.00
568-467	1.0" - 1.2"			\$2,156.00	\$1,724.80
568-468	1.2" - 1.6"			\$2,395.00	\$1,916.00
568-469	1.6" - 2.0"		\$2,395.00	\$1,916.00	
568-470	2.0" - 2.5"		150mm (952623)	\$2,339.00	\$1,871.20
568-471	2.5" - 3.0"			\$2,423.00	\$1,938.40
568-472	3.0" - 3.5"			\$2,465.00	\$1,972.00
568-473	3.5" - 4.0"	\$2,465.00		\$1,972.00	
568-474	4.0" - 4.5"	\$2,578.00		\$2,062.40	
568-475	4.5" - 5.0"	\$2,719.00	\$2,175.20		

Technical Data

Resolution: 0.001mm or 0.00005 in/0.001mm
Display: LCD
Response speed: Infinite
Battery: SR44 (1 pc), 938882, for initial operational checks (standard accessory)
Battery life: Approx. 5,000 hours in continuous use
Scale type: Electrostatic capacitance ABSOLUTE encoder

Functions

GO/NO-GO judgment, GO/NO-GO judgment zoom, 2-Point preset, Zero-setting, Data hold, Error alarm, Low battery voltage alert, Data output, Function lock, 330° Rotary display, inch/mm conversion (inch/mm models)

Complete Unit Gage Sets: includes several individual gages to cover the overall size range of the set

Order No	Overall Range	Range of Individual Gages	Setting Rings	List	Promo
568-965	0.275" - 0.5"	0.275-0.35", 0.35-0.425", 0.425-0.5"	0.35" DIA., 0.425" DIA.	\$7,058.00	\$5,646.40
568-966	0.5" - 1"	0.5-0.65", 0.65-0.8", 0.8-1"	0.65" DIA., 0.8" DIA.	\$7,368.00	\$5,894.40
568-967	1" - 2"	1-1.2", 1.2-1.6", 1.6-2"	1.2" DIA., 1.6" DIA.	\$7,692.00	\$6,153.60
568-968	2" - 3"	2-2.5", 2.5-3"	2.5" DIA.	\$5,508.00	\$4,406.40
568-969	3" - 4"	3-3.5", 3.5-4"	3.5" DIA.	\$6,113.00	\$4,890.40



Complete-Unit Set

Interchangeable-Head Sets

Order No	Overall Range	Range of Individual Gages	Setting Rings	List	Promo
568-928	0.275" - 0.5"	0.275-0.35", 0.35-0.425", 0.425-0.5"	0.35" DIA., 0.425" DIA.	\$3,142.00	\$2,513.60
568-929	0.5" - 1"	0.5-0.65", 0.65-0.8", 0.8-1"	0.65" DIA., 0.8" DIA.	\$3,564.00	\$2,851.20
568-930	1" - 2"	1-1.2", 1.2-1.6", 1.6-2"	1.2" DIA., 1.6" DIA.	\$4,339.00	\$3,471.20
568-936	2" - 4"	2-2.5", 2.5-3", 3-3.5", 3.5-4"	2.5" DIA., 3.5" DIA.	\$6,254.00	\$5,003.20



Interchangeable-Head Set

Includes one digital display unit with several interchangeable measuring heads (and adapters as required) to cover the total size range plus one extension rod

All prices are Canadian Dollar

PH-3515F Profile Projector and 2D Processor Packages

Heavy-Duty, Bench-Top Model with Horizontal Optical System featuring display w/ M2 geometric measuring software

- > ø14" screen, Horizontal Projector
- > 10" x 6" Travel T Slot table for accessories
- > Linear Glass Scales for accurate measurement
- > Profile and Fiber Optic Surface Illumination
- > Digital built-in angle counter
- > Maximum Load 45kg / 100lb
- > Available with M2 or QM Data 2D Processors

Order No.	Description	List	Promo
PH-3515 Main Unit & Digital Readout Packages 5% Off			
M172868-1	PH-3515F KA Counter PKG # 1	\$16,211.00	\$15,400.00
M172868-2	PH-3515F QM-DATA PKG # 2	\$18,866.00	\$17,922.00
M172868-3	PH-3515F QM-DATA/OPT200 PKG # 3	\$21,801.00	\$20,711.00
M172868-4	PH-3515F - M2 ADD-ON & Touch Screen PC	\$21,510.00	\$20,435.00
M172868-5	PH-3515F - M2 ADD-ON, Touch Screen PC & Automatic Edge Detection	\$23,000.00	\$21,850.00
Machine Stand (Optional)			
64PMI308	Machine Stand for PH Series	\$1,830.00	\$1,350.00
64AAB149	Tray, Counter, PH-A14/PH-3515	\$206.00	-

(Includes installation and A2LA accredited calibration)

5% OFF 5% off all Main Units



5% OFF 5% off all Packages



FREE SHIPPING Free Shipping



Installation & Calibration Included

172-868-11A-M2

PH-3515 Profile Projector, M2 Software/ Hardware and All-In-One Touchscreen PC



KA-200 Counter: PH-3515 & PV-5110

MeasurLink ENABLED
Data Management Software by Mitutoyo



Display unit for X & Y Linear Scales
 > ABSOLUTE and incremental modes (10 presets each)
 > 0.05-.0001mm / .02" - .000005" in resolution
 > Calculator functionality

Compatible Digital-Read-Out (DRO) Devices

M2 Software & Hardware: PH-3515 & PJ-PLUS



MeasurLink ENABLED
Data Management Software by Mitutoyo

M2 is a universal 2D coordinate measurement software which has become the preferred software for many optical comparator users due to its intuitive user interface and data collection procedures.

- > Software & All-In-One Touch Screen PC Included
- > Full Integration and A2LA Calibration conducted

Automatic Edge Detection

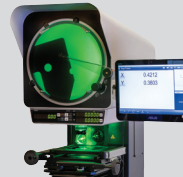

Fiber Optic Edge Detection system integrated into M2 software via M2 Communication Unit.
 Intuitive Edge Teach Functionality built into software.
 Allows for continuous measurement of features, while storing data for post process analysis.

PJ-Plus with M2 2D Processor Packages

The PJ-Plus is a new series of profile projectors offered by Mitutoyo. This system utilizes LED lighting and a fanless design making it ideal for harsh manufacturing facilities or job shops.

Order No	Description	XY Stage	List	Promo
PJ-PLUS Main Units - 5% Off				
302-801-10A	PJ-P1010A 4x4"/100x100m	4x4"/100x100m	Request a Quote	
302-802-10A	PJ-P2010A 8X4"/200x200mm	8X4"/200x200mm		
PJ-PLUS & M2 Packages - 5% Off				
302-801-10-M2	PJ-PLUS 4x4 - M2 and Touchscreen PC Package	4x4"/100x100mm	Request a Quote	
302-801-10-M2-EDGE	PJ-PLUS 4X4 - M2, Optical Edge Detection and Touchscreen	4x4"/100x100mm		
302-802-10-M2	PJ-PLUS 8x4 - M2 and Touchscreen PC Package	8x4"/200x100mm		
302-802-10-M2-EDGE	PJ-PLUS 8x4 - M2, Optical Edge Detection and Touchscreen	8x4"/200x100mm		
Machine Stand (Optional)				
64PMI167	Machine Stand for PJ Series		Request a Quote	

5% OFF 5% off all Main Units



5% OFF 5% off all Accessory Packages



FREE SHIPPING Free Shipping



Installation & Calibration Included

302-801-10-M2-EDGE



MeasurLink ENABLED
Data Management Software by Mitutoyo

An XY axis digital counter is built into the PJ-Plus



Prices effective April 1 through June 30, 2025

PV-5110 Vertical (Downward) Profile Projector (5% OFF Main Unit & 5% OFF DRO)

The PV-5110 Profile Projector is a downward optical axis projector fitted with a stable glass stage for delicate item inspection, ensuring accuracy and preventing damage. Its advanced optics and secure platform make it an optimal choice for precise applications, particularly with thin or delicate workpieces.

- > Ø19.4" Screen, Vertical Projector.
- > Downward Optical Axis - Provides improved oblique surface illumination.
- > LED illumination.
- > Built-In Dual Oblique Surface Illumination for improved contrast.

Order No.	Description	List	Promo
PV-5110 Main Unit & Digital Readout Interface Packages - 5% Off			
304-919-11A-KA	PV-5110 with KA Counter	Request a Quote	
304-919-11A-QM	PV-5110 with QM Data		
304-919-11A-QM-OPT	PV-5110 with QM Data and Optoeye		

PLEASE NOTE: No stand or elevated surface is required.

5% OFF 5% off all Main Units



5% OFF 5% off all Packages



FREE SHIPPING Free Shipping



Installation & Calibration Included

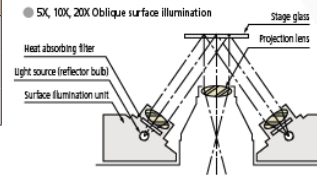

304-919-11A-KA
PV-5110 with KA Counter

Additional DRO

QM Data: PH-3515, PJ-PLUS, PV-5110 & PJ-H30

The QM-Data200 unit features the powerful QM 2D coordinate measurement software pre-loaded onto our rugged user interface. The QM-Data200 interface features easy-to-use key operations and allows for measurement results to be visualized on its LCD Display.

MeasurLink ENABLED
Data Management Software by Mitutoyo



Plot Single Data Points



Return 2-Dimensional Graphic and Calculated Values

- > Built-In Guided Measurement Tutorials.
- > Programmable Measurement Procedures & Calculations.
- > Data Collection and USB Output.
- > Full Integration and A2LA Calibration conducted by Mitutoyo Field Service team.

Optoeye-200

Optical Edge Detection (Additional Purchase Required)



PJ-H30 Vertical Profile Projector

The Mitutoyo PJ-H30 is unique given its ability to produce an uninverted image, improving intuitive operation as the projected image appears in the same orientation as the workpiece.

- > Optical system with high NA lenses provides bright and high contrast images
- > The three-lens mounting turret includes a 10X lens as standard
- > Built-in digital XY Counter

303-716-13A &
264-131-13A-PJH-OPT



25% OFF 25% off all Main Units



5% OFF 5% off all Accessory Packages



FREE SHIPPING Free Shipping



Installation & Calibration Included

MeasurLink ENABLED
Data Management Software by Mitutoyo



303-717-13A PJ-H30A2010B

Order No.	Description	XY Travel	List	Promo
PJ-H30 Main Units - 25% OFF				
303-716-13A	PJ-H30A1010B	4x4"/100x100mm	Request a Quote	
303-717-13A	PJ-H30A2010B	8x4"/200x100mm		
303-718-13A	PJ-H30A2017B	8x6.7"/200x170mm		
303-719-13A	PJ-H310A3017B	12x6.7"/300x170mm		
Digital Readout Interface (Add-On Packages - Optional) - 5% Off				
264-161-13A-PJH	QM-DATA200 Arm Type (PJ-H Series Package)		Request a Quote	
264-161-13A-PJH-OPT	QM-DATA200 Arm Type & Optoeye (PJ-H)			
Machine Stand (Optional)				
64PMI167	Machine Stand for PJ Series		Request a Quote	

All prices are in Canadian Dollars

Quick Image

A double telecentric optical system with a large depth of focus, quick release stage, and a large selection of stage sizes make the Quick Image a high-efficiency VMM.

- > Manual or motorized stages available.
- > High pixel count color camera.
- > Automatic part location with pattern search tool.
- > CAD file overlay.
- > Profile of a line built in.
- > Stitching function allows for measurements of parts larger than the field of view.

Model No.	Package	Stage Size	List
QI-A1010D	361-850M3PK	4" x 4"	Request a Quote
QI-A2010D	361-851M3PK	8" x 4"	
QI-A2017D	361-852M3PK	8" x 7"	
QI-A3017D	361-853M3PK	12" x 7"	
QI-A4020D	361-854M3PK	16" x 8"	

Packages include machine, PC, software, installation, ISO 17025 accredited calibration, and online training
 * Manual Stage

- FREE SHIPPING Free Shipping
- +
- Installation & Calibration Included
- +
- Online Training Course Included



M3 Software

An intuitive and thoughtful icon-driven user interface, a flexible probe library, and powerful tolerancing and programming make M3 the perfect solution for the Quick Image system.

- > Includes profile
 - Allows profile of a line comparing measured points to a nominal CAD file
- > Includes DXF overlay
 - Overlay a CAD file, similar to a profile projector overlay
- > Includes image stitching
 - Measure large parts by combining multiple fields of view into a single image
- > Includes pattern search
 - Automatically locate and measure a part regardless of size or orientation
- > Includes program finder
 - Automatically identify a part and load the corresponding part program
- > Includes multi-measure
 - Measure multiple features by drawing a box around them



Errors due to height are greatly minimized with a depth of focus up to 22mm. Measurement errors due to human focusing are eliminated.

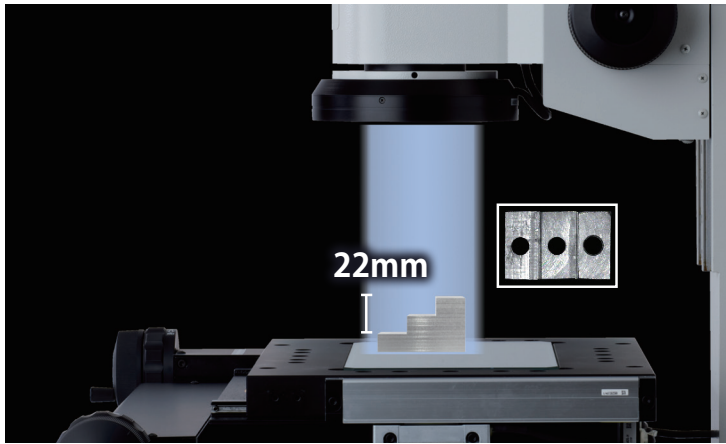

Measuring a stepped workpiece

Model No.	Package	Stage Size	List
QI-C2010D	361-860-11M3PK	8" x 4"	Request a Quote
QI-C2017D	361-861-11M3PK	8" x 7"	
QI-C3017D	361-862-11M3PK	12" x 7"	

Packages include machine, PC, software, installation, ISO 17025 accredited calibration, and online training
 * Motorized Stage

Auto-Recognition

Use pattern search for multiple workpieces within the screen view, and measure them all in one operation with a single touch or mouse click. This eliminates the need for accurate positioning of workpieces and cumbersome setup of fixtures.

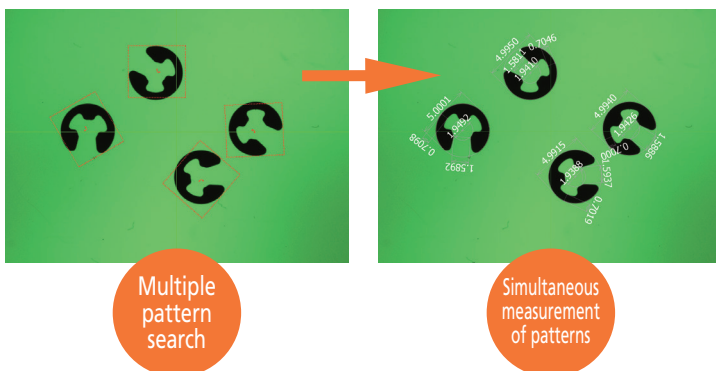

Optional Thread Module

Adds the ability to inspect external thread features and quickly calculate the Outside and Root Thread Diameters, the Pitch Diameter, the Lead, and the Root and Crest Truncation values.

Model No.	Package	List
64VIS002	LF-TM	Request a Quote

* For M3 software

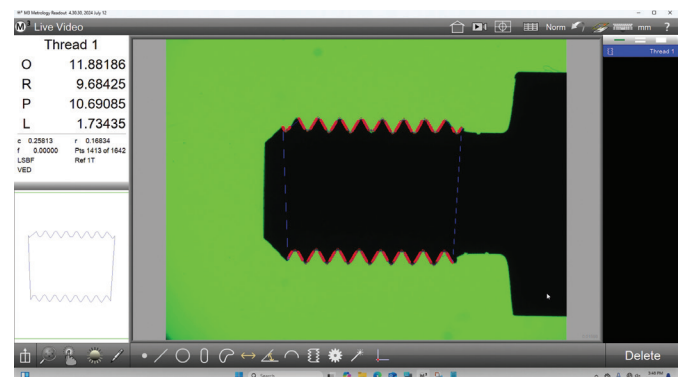

All prices are in Canadian Dollars

High-Accuracy Height Gage Linear Height LH-600F/FG

The highest accuracy height gage on the market is now even easier to use.

The Mitutoyo LH-600F Linear Height Measurement System is the latest model in the Mitutoyo Linear Height Gage line, designed to be more user-friendly while maintaining the best-in-class reliability and accuracy of previous models.



New Features:

- > Rotatable, adjustable touch screen interface.
- > New self-check feature.
- > High-accuracy encoder more resistant to contaminants.
- > Improved 2D mode.
- > Calibration date warning.
- > S1 Digimatic output capable of sending data directly to Excel®, wired or wirelessly.
- > Additional probe and extension options.

Still Featuring:

- > Resolution down to 0.1µinch (selectable).
- > Highest accuracy in its class $\pm (1.1+0.6L/600) \mu\text{m}$.
- > Pneumatic full/semi-float system with built-in compressor.
- > Capable of standard measurements such as heights and diameters or advanced measurements like angles, diagonal distances and perpendicularity (optional probes may be required).
- > The Origin can be set at centerline positions, peaks of radii or simply on the surface plate or gage blocks.



Power grip model also available for even easier positioning.

Perpendicular/straightness measurement - Graph creation

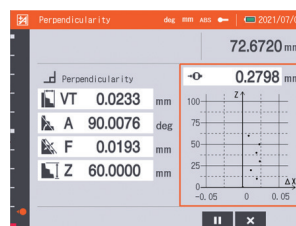

Show results in real time during measurement.

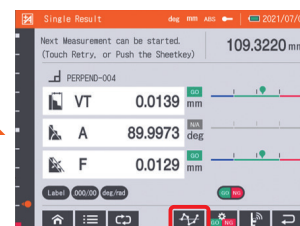

Show results after measurement.

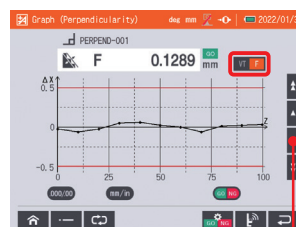

You can monitor the graphs of past measurement results.

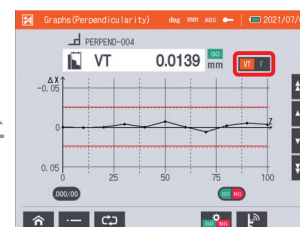

Show measurement results in graph form.

Order No	Description	Range (Stroke)	Resolution (selectable)	List	Promo
518-360-13	LH-600F Inch/mm	977mm (600mm) / 38" (24")	0.0001/0.001/0.01/0.1mm .0000001/.000001/.00001/.0001"	\$12,994.00	\$11,694.60
518-361-13	LH-600FG Inch/mm, Power Grip Model			\$13,593.00	\$12,233.70

* Must purchase Power Cord 02ZAA011

Prices effective April 1 through June 30, 2025

Easy operation using keypad and touch screen navigation

Contextual guidance on the large-screen touch panel supports your measurements.



Simple, straightforward keys with icons

Icons allow the user to find the required operation at a glance.

Basic measurements



Height (top) measurement



Height (bottom) measurement



Width (inside) measurement



Width (outside) measurement



Shaft (top) measurement



Shaft (bottom) measurement



Circle (shaft) measurement



Max.-Min. (top) measurement



Hole (bottom) measurement



Hole (top) measurement



Circle (hole) measurement



Max.-Min. (bottom) measurement

Advanced measurement functions



Part program measurement



2D measurement

Power



Power

Measurement settings



Measurement origin setting



Probe selection



Measurement origin switching

Other



Home screen



System settings



Data output

Touch panel with guidance

Measurement guidance is displayed on the large touch panel of the 8.4-inch color LCD, enabling intuitive operation.



Guidance screen



Operable with gloves

Expanded measurement area

With the new optional probes, you can now measure areas that were beyond the capacity of conventional probes.

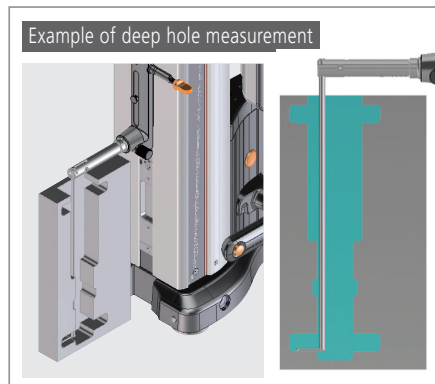
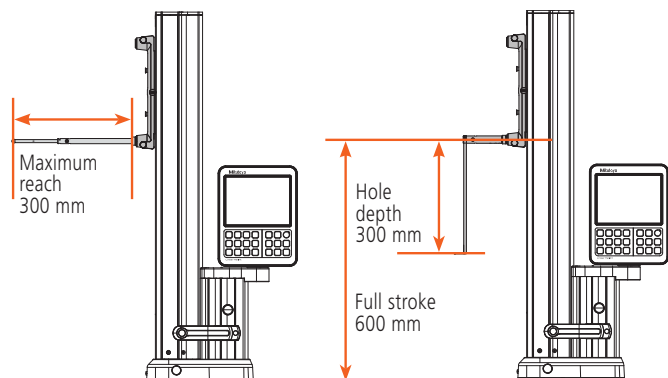

To see full brochure, use the QR code below.



All prices are in Canadian Dollars

ABSOLUTE 1D Height Gage QM-Height Series

- > High-resolution ABSOLUTE linear encoder for position detection.
- > High-accuracy: $\pm(2.4 + 2.1L / 600)\mu\text{m}$.
- > Pneumatic flotation system / positioning grip allows for smooth movement along surface plate (select models).
- > Large, stationary display panel with user-friendly icon control keys and GO/NO-GO LED indicator.
- > Digital and USB output: Supports Mitutoyo wireless SPC output.
- > Fully compatible with existing Mitutoyo Digimatic peripherals (SPC cables, U-WAVE wireless transmitters, multiplexers, etc.).
- > Battery life of 1200 hours in continuous use with four AA batteries, an improvement from 300 hours.

GO/ \pm NG judgment by LED (red, orange, green) and measurement examples

- > LEDs are activated at the time of tolerance judgment: green for GO, red for +NG, and orange for -NG. -NG, GO and +NG also appear on the LCD.



"d2" is the name for Mitutoyo Digimatic output compatible with up to 8 digits of I/O data.

MeasurLink ENABLED
Data Management Software by Mitutoyo

d2 Digimatic and USB outputs

- Digimatic and USB ports are provided as standard. Using the U-WAVE-T measurement data wireless communication system enables instant transmission of measurement data to a PC via wireless communication which reduces manual input errors and improves data reliability and operational efficiency.



- > Measure diameters, gap distances, center-to-center distances, and more.
- > Sub-display can show difference between current and previous measurement or distance from current measurement to origin.
- > The origin can be set at the top of a surface plate, centerline, or any top or bottom surface within its range.

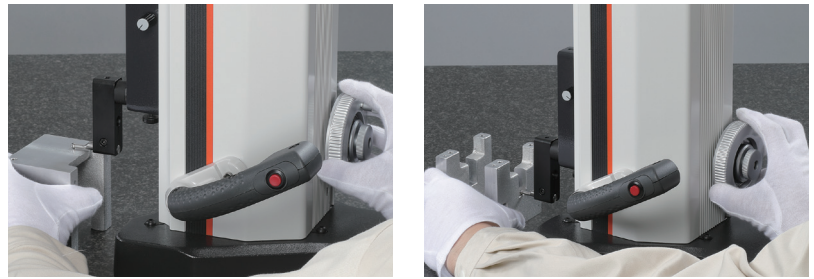

Measurement Examples

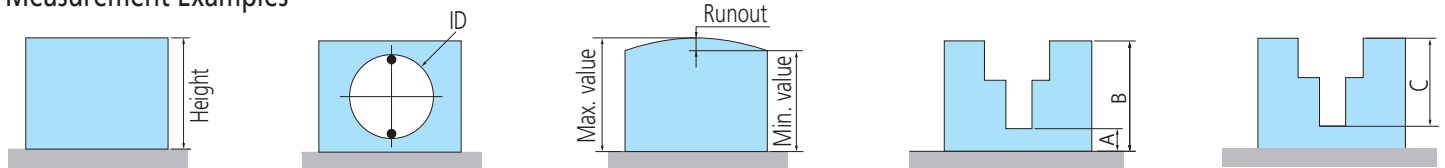

Part No.	Range	Resolution	Remarks	List	Promo
64PKA094C	0 - 14" / 0 - 350mm	0.001mm / 0.0005mm / .00005" / .0001" (selectable)	Pneumatic Flotation System	\$5,501.00	\$5,225.95
64PKA095C	0 - 24" / 0 - 600mm			\$6,154.38	\$5,846.66
64PKA129C	0 - 14" / 0 - 350mm			\$6,401.00	\$6,080.95
64PKA130C	0 - 24" / 0 - 600mm			\$6,855.00	\$6,512.25

Optional Accessories

Order No.	Description	List	Promo
12AAC072	DEPTH PROBE	\$283.00	\$268.85
12AAA837	INDICATOR HOLDER (ACCEPTS 3/8" STEM)	\$206.00	\$195.70
12AAA793	PROBE EXTENSION HOLDER (3.3" / 85mm)	\$229.00	\$217.55
226118	SHANK WITH M3 THREAD SCREW	\$145.00	\$137.75
957265	20MM DIA. DISK STYLUS FOR LINEAR HEIGHT	\$543.00	\$515.85
957264	14MM DIA. DISK STYLUS FOR LINEAR HEIGHT	\$443.00	\$420.85
12AAF669	10PI BALL CONTACT POINT(COAXIAL)	\$335.00	\$318.25
957261	2MM DIA. BALL STYLUS FOR LINEAR HEIGHT	\$301.00	\$285.95
517-814-10	GRAPLATE 36X48" GRADE A	\$3,245.00	\$3,082.75
517-964-10	GRAPLATE STAND 36X48"	\$2,000.00	\$1,900.00
517-808-10	GRAPLATE 24X36" GRADE A	\$1,492.00	\$1,417.40
517-956-10	GRAPLATE STAND 24X36"	\$1,890.00	\$1,795.50
06AFM380D	USB-ITN-D INPUT TOOL DIRECT CABLE	\$278.00	\$264.10
02AZD730G-D	U-WAVE TRANSMITTER W/ CONNECTING CABLE (D)	\$464.00	\$440.80
02AZD810D	U-WAVE-RECEIVER	\$717.00	\$681.15



All prices are in Canadian Dollars

Coolant-Proof Calipers

- > Sealed housing is IP67 rated, meaning it's resistant to the coolants, dirt, grit and chips found in many manufacturing environments.
- > Easy to use - no need to wipe or clean the scale.
- > .0005"/0.01mm resolution with ± 0.001 " accuracy.
- > Automatic power-on/off.
- > Certificate of Inspection provided.



COMPATIBLE WITH
U-WAVE fit

MeasurLink ENABLED
Data Management Software by Mitutoyo

Order No.	Range	List	Promo
Non-Output Style			
500-752-20	0-6"/0-150mm	\$295.00	\$251.00
500-753-20	0-8"/0-200mm	\$397.00	\$377.00
500-754-20	0-12"/0-300mm	\$601.00	\$571.00
SPC Output Style			
500-762-20	0-6"/0-150mm	\$351.00	\$333.00
500-763-20	0-8"/0-200mm	\$452.00	\$429.00
500-764-20	0-12"/0-300mm	\$760.00	\$646.00



* ± 0.0015 " accuracy U-WAVE Fit compatible

SPC cable - 1m: 05CZA624 2m: 05CZA625



COOLANT PROOF™ IP67

COOLANT PROOF is the universal term of Mitutoyo Digimatic Small Tool Instruments that are free from measurement error and physical deterioration due to routine exposure to water, cutting oil or coolant. This high performance is achieved by using encoders that are inherently immune to contamination, where exposure is inevitable, combined with comprehensive sealing techniques and extremely oil-resistant materials to guarantee a long working life under normal operating conditions.

Digimatic Carbon Fiber Caliper



552-314-10



MeasurLink ENABLED
Data Management Software by Mitutoyo

Order No.	Range	Accuracy	Resolution	List	Promo
552-312-10	0(.5")-18"	+/- .002"	.0005"/0.01mm	\$1,341.00	\$1,206.90
552-313-10	0(.5")-24"	+/- .002"	.0005"/0.01mm	\$1,503.00	\$1,352.70
552-314-10	0(1")-40"	+/- .002"	.0005"/0.01mm	\$2,683.00	\$2,414.70
552-315-10	0(1")-60"	+/- .004"	.0005"/0.01mm	\$3,206.00	\$2,885.40
552-316-10	0(1")-80"	+/- .005"	.0005"/0.01mm	\$5,018.00	\$4,516.20

SPC cable - 1m: 05CZA624 2m: 05CZA625

- > Lightweight Digimatic Calipers that employ CFRP (Carbon Fiber Reinforced Plastics) in the beam and jaws.
- > Highly durable and easy to handle.
- > Direct readout of ID measurements from the LCD. (Offset value can be set easily by pressing the Offset key.)
- > Preset function for setting a desired starting point.
- > With SPC data output.
- > Special models available with ceramic jaws which are suitable for measuring abrasive and magnetic products.
- > Can be used in workshop conditions exposed to coolant, water, dust or oil.
- > Incorporates ABSOLUTE measurement system.
- > Automatic power-on/off.



CERA Caliper Checker

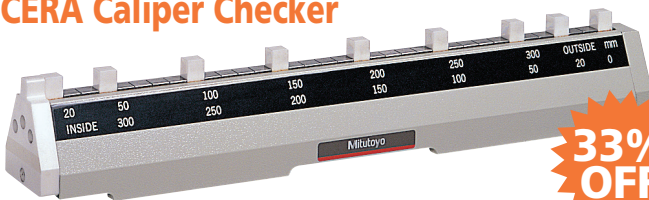

Order No.	Range	Remarks (length to check)	List	Promo
515-565	0 - 12"	Outside measurement: 1", 2", 4", 6", 8", 10", 12" Inside measurement: 1", 2", 4", 6", 8", 10", 12"	\$6,443.00	\$4,316.81

CERA Caliper Checker

- > Permanently wrung, high grade CERA gage blocks in a protective metal casing.
- > Stands perpendicular for height gage inspection.

* Also includes same features as CERA Gage Blocks

CERA (Zirconia Ceramic) Gage Blocks*

- > Extremely high wear resistance, 3x better than carbide.
- > Corrosion proof - no oil needed.
- > Closest expansion coefficient to steel.
- > Anti-magnetic - keeps away steel dust.
- > High wringing force due to high density.
- > Crack and burr resistant.
- > Low thermal conductivity - excellent dimensional stability under brief temperature changes (from handling, etc.).

Prices effective April 1 through June 30, 2025

Digimatic Calipers

- AOS Electromagnetic inductive sensor improves environmental resistance against dirt, water and oil.
- A battery life of approximately 3.5 years has been achieved under normal use through the adoption of the Mitutoyo ABSOLUTE scale.
- The slider configuration features an ergonomic, thumb-friendly shape.
- Step-measurement capable.
- The data output function allows integration into Statistical Process Control and measurement systems.
- Display character height: 9mm.
- AOS applies to 4", 6" and 8" models.
- Resolution: .0005"/0.01mm.



Order No.	Range	Remarks	List	Promo
No SPC Output Style				
500-195-30	0-4"/0-100mm	.075" Round Depth Bar	\$205.00	\$199.00
500-196-30	0-6"/0-150mm		\$221.00	\$210.00
500-197-30	0-8"/0-200mm		\$319.00	\$303.00
500-193-30	0-12"/0-300mm		\$636.00	\$541.00
With SPC Output Style				
<i>fit</i> 500-170-30	0-4"/0-100mm	.075" Round Depth Bar	\$243.00	\$236.00
<i>fit</i> 500-171-30	0-6"/0-150mm		\$259.00	\$246.00
500-172-30	0-8"/0-200mm		\$342.00	\$332.00
500-173-30	0-12"/0-300mm		\$700.00	\$595.00
500-505-10	0-18"/0-450mm	Without Thumb Roller	\$1,161.00	\$1,103.00
500-506-10	0-24"/0-600mm	Without Thumb Roller	\$1,276.00	\$1,212.00
500-507-10	0-40"/0-1000mm	Without Thumb Roller	\$2,455.00	\$2,332.00

fit U-WAVE-Fit compatible

SPC cable with data switch - 1m: 959149 2m: 959150

Dial Caliper

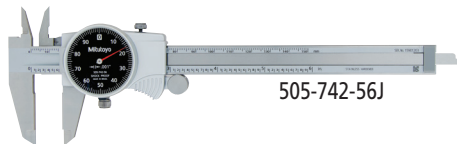

- Smooth sliding with high shock protection.
- Lock screw for dial bezel and for holding the sliding jaw position.
- Can measure OD, ID, depth and steps.
- Models available with carbide-tipped OD and ID jaws.

Order No.	Range	Remarks	List	Promo
505-742J	0-6" .100"/rev		\$189.00	\$180.00
505-738	0-6" .100"/rev	Carbide-tipped jaws	\$294.00	\$279.00
505-740J	0-6" .200"/rev		\$171.00	\$162.00
505-743J	0-8" .100"/rev		\$250.48	\$213.00
505-746	0-12" .100"/rev		\$390.23	\$371.00
505-749	0-12" .200"/rev		\$370.00	\$315.00
505-742-56J	0-6" .100"/rev	Black Dial Face	\$189.00	\$180.00

Offset Caliper

- Main scale jaw can slide up and down to facilitate measurement of stepped sections. (Hard-to-reach dimensions such as A, B, C can be accurately measured).
- With depth bar.
- With SPC data output.

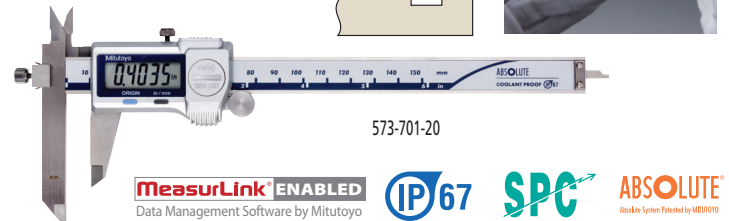

Order No.	Range	Accuracy	Resolution	List	Promo
<i>fit</i> 573-701-20	0-6"/0-150mm	±.001"	.0005"/0.01mm	\$657.00	\$624.00
<i>fit</i> 573-702-20	0-8"/0-200mm	±.001"	.0005"/0.01mm	\$754.00	\$716.00
<i>fit</i> 573-704-20	0-12"/0-300mm	±.0015"	.0005"/0.01mm	\$1,012.00	\$961.00

fit U-WAVE-Fit compatible

SPC cable with data switch - 1m: 05CZA624 2m: 05CZA625

Point Caliper

- Narrow tip jaws fit into very small grooves and tracks, making many previously difficult outside measurements easier to achieve.
- With depth bar.
- With SPC data output.

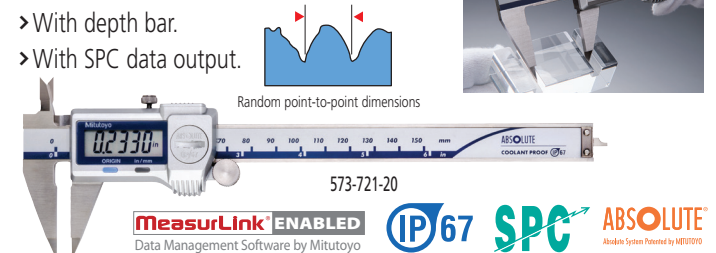

Order No.	Range	Accuracy	Resolution	List	Promo
<i>fit</i> 573-721-20	0-6"/0-150mm	±.001"	.0005"/0.01mm	\$576.00	\$490.00
<i>fit</i> 573-725-20*	0-6"/0-150mm	±.001"	.0005"/0.01mm	\$716.00	\$680.00

* Extended tips *fit* U-WAVE-Fit compatible

SPC cable with data switch - 1m: 05CZA624 2m: 05CZA625

Low-force Caliper

- Due to the low measuring force, these calipers are ideal for elastic or resilient workpieces such as plastic parts and rubber parts that standard calipers can't measure consistently.
- With SPC data output.



Order No.	Range	Accuracy	Resolution	List	Promo
<i>fit</i> 573-291-30	0-7"/0-180mm	±.002"	.0005"/0.01mm	\$1,168.00	\$1,133.00

fit U-WAVE-Fit compatible

All prices are in Canadian Dollars

Quickmikes

The new Quickmike series still boasts the super-fast spindle feed rate that's **20x faster** than standard micrometers.

- > IP65 protection – can be used around cutting fluids.
- > MIN Hold – the minimum measurement can be held on the display for more repeatable and accurate measurements.
- > Larger LCD – 33% larger, 10mm character height.
- > Function lock – prevents accidental changes.
- > 5 year battery life – more operating time, less downtime looking for and replacing batteries.
- > Non-rotating spindle.



MeasurLink ENABLED
Data Management Software by Mitutoyo

ABSOLUTE™ SPC
COOLANT PROOF™ IP65

Order No.	Range	Resolution	Accuracy	Flatness	Parallelism	List	Promo
293-676-20	0 - 1.2"	.00005"/0.001mm	±0.0001"	0.000012"	0.00008"	\$836.00	\$794.00
293-677-20	1 - 2.2"	.00005"/0.001mm	±0.0001"	0.000012"	0.00008"	\$913.00	\$867.00

SPC cable with data switch – 1m: 05CZA662 2m: 05CZA663



MDC-Lite Micrometer

- > Provided only with zero set and in/mm (inch/metric models only) keys.
- > A ratchet stop or friction thimble for a constant measuring force.
- > Measurement readout with large characters on the LCD.
- > No spindle clamp. No data output.

Order No.	Range	Resolution	Remarks	List	Promo
293-831-30	0 - 1" / 0 - 25.4mm	.00005" / 0.001mm	Ratchet Stop	\$198.00	-
293-832-30	0 - 1" / 0 - 25.4mm	.00005" / 0.001mm	Friction Thimble	\$209.00	-



Digimatic Micrometer

- > New electromagnetic ABSOLUTE sensor - Improved resistance to environmental conditions such as dirt, oil and water, which can cause false readings.
- > New ratchet thimble on select models improves one-hand operability.
- > New anti-slip finish for improved grip while taking measurements.
- > Long battery life – 2.4 years under normal operation.
- > Fully compatible with existing Mitutoyo Digimatic peripherals (SPC Cables, U-WAVE wireless transmitters, DP1-VA, etc.) – SPC output-enabled IP65 models.
- > Function-lock system prevents inadvertent setting changes.
- > Certificate of Inspection provided.

SPC
COOLANT PROOF™



Order No.	Range	Resolution	Remarks	List	Promo
fit 293-330-30*	0-1"/0-25.4mm	.00005"/0.001mm	Ratchet Stop	\$341.00	\$324.00
293-340-30	0-1"/0-25.4mm	.00005"/0.001mm	Ratchet Stop	\$268.00	\$260.00
293-344-30	0-1"/0-25.4mm	.00005"/0.001mm	Ratchet Thimble	\$268.00	\$260.00
293-348-30	0-1"/0-25.4mm	.00005"/0.001mm	Friction Thimble	\$270.00	\$261.90
293-349-30	0-1"/0-25.4mm	.0001"/0.001mm	Ratchet Thimble, Tenths Reading	\$270.00	\$262.00
fit 293-331-30*	1-2"/25.4-50.8mm	.00005"/0.001mm	Ratchet Stop w/Standard	\$399.00	\$379.00
293-341-30	1-2"/25.4-50.8mm	.00005"/0.001mm	Ratchet Stop w/Standard	\$343.00	\$326.00
293-345-30	1-2"/25.4-50.8mm	.00005"/0.001mm	Ratchet Thimble w/Standard	\$343.00	\$326.00
fit 293-334-30*	0-1"/0-25.4mm	.00005"/0.001mm	Ratchet Thimble	\$365.00	\$347.00
fit 293-335-30*	0-1"/0-25.4mm	.00005"/0.001mm	Friction Thimble	\$340.00	\$330.00

*with SPC Output

fit U-WAVE Fit compatible

SPC cable with data switch – 1m: 05CZA662 2m: 05CZA663

MeasurLink ENABLED
Data Management Software by Mitutoyo



Purchase the world's first 5µinch /0.1µm resolution micrometer and receive a USB input tool and cable (over \$394 in value)

Using precision digital measuring tools together with a USB input tool improves both measurement results and data reliability. The high-accuracy MDH with 5 millionths resolution can output in its entirety in both inch and metric. Resulting data can input directly to Excel®, MeasurLink® or other SPC programs.

> Range: 0-1", Resolution: .000005", Accuracy: +/- .000020

Part No.	Description	List
293-130-10	MDH Micrometer with high accuracy, high resolution output	\$2,308.00
05CZA662	SPC CONNECTING CABLE (1M)	Included
264-020	USB INPUT TOOL	Included



ABSOLUTE Digimatic Height Gages

Popular Mitutoyo single-beam height gages have been redesigned to be even easier to use with larger displays, various hardware accessories, and multiple data options such as wired and wireless output, data loggers and more.

Features:

- > Durable Build - Iron detector and base, steel beam and holder.
- > Easy to use slider feed wheel.
- > Multiple data equipment options.
- > Other improvements: twist-off battery cap, 20% larger LCD, handy Data button.



Shown with optional Test Indicator and mounting hardware (see page 9).



Shown with optional U-Wave Bluetooth® transmitter (see page 28 and connector 02AZD790F)



570-412

MeasurLink ENABLED
Data Management Software by Mitutoyo



Order No.	Range	Resolution	Functions	Drive Method	Data Output	Max. response speed	Battery Life	List	Promo
570-412	0"-12"/0mm-300mm	0.0005" / 0/01mm	On/Off, Origin, Zero/ABS, Hold/Data, inch/mm conversion"	Slider-feed Wheel (manual)	Digimatic d1	Unlimited	Approx. 5 Years Under Normal Use	\$1,033.00	\$1,002.00
570-413	0"-18"/0mm-450mm							\$1,383.00	\$1,313.85
570-414	0"-24"/0mm-600mm							\$1,610.00	\$1,530.00

All prices are in Canadian Dollars

U-WAVE is a wireless system that turns any Mitutoyo gage with Digimatic output into a wireless keyboard for fast, error-free data collection. U-WAVE transmitters now come in three models: Bluetooth®, Fit and Standard. Send data with a push of a button or request it from the PC or mobile device.



U-WAVE Bluetooth®

U-WAVE-TMB/TCB

The new U-WAVE Bluetooth® transmitter features:

- Now utilizes the popular Bluetooth® 4.2 Low Energy Wireless Technology.
- This new Bluetooth® version of U-WAVE allows a simple connection to smartphones, tablets and Bluetooth® enabled Laptops and PC's.
- The same low-profile and ergonomic fit benefits of the U-WAVE-Fit.
- A buzzer type and IP67 type with dustproof and waterproof specifications are available.
- Up to 7 units can be connected to 1 Bluetooth® enabled PC without a receiver.
- New U-WAVEpak for Android, iOS and Windows available at no cost.



Request an assessment to determine how quickly your company can obtain a full ROI

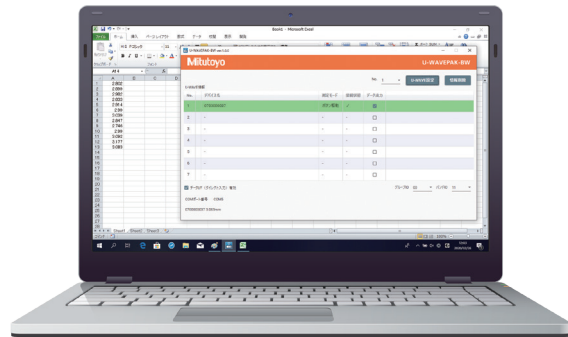
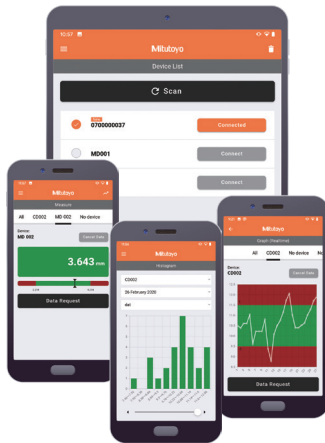

The measurement data is used to make the software in the PC Transferable PC Communication Software U-WAVEPAK-BW.

The Google Play and Google Play logos are trademarks of Google LLC. The Apple and Apple logos are trademarks of Apple Inc.

IP67

U-WAVE-TMB



MeasurLink ENABLED
Data Management Software by Mitutoyo



U-WAVE-TCB



U-WAVE-TMB/TCB*

Order No.	Model	Measuring Instrument*	Remarks	List	Promo
264-624-IP-S	U-WAVE-TCB	4", 6", 8", 12" standard caliper	Transmitter and Connection Unit	\$409.00	\$368.10
264-624-IP	U-WAVE-TCB	4", 6", 8", 12" IP67 caliper	Transmitter and Connection Unit	\$409.00	\$368.10
264-626-IP-M	U-WAVE-TMB	Coolant-proof (IP65) micrometer Micrometers (excl. S1, excl. QuickMike)	Transmitter and Connection Unit	\$409.00	\$368.10
02AZF700-TMB	U-WAVE-TMB	0.5" (12.5mm) Stroke for S1 Indicators	Transmitter and Connection Unit	\$434.00	\$390.60
02AZG011-TMB	U-WAVE-TMB	1" (25.4mm) Stroke or Larger for S1 Indicators	Transmitter, Bracket, and Connection Unit	\$509.00	\$458.10

* No U-WAVE Receiver required

Prices effective April 1 through June 30, 2025

U-WAVE Wireless Data Transmitters

All prices are in Canadian Dollars

The new Mitutoyo U-WAVE-Fit wireless data transmitter fits to the back of popular Mitutoyo hand-held measuring instruments. This new design allows for a snug fit behind the display resulting in a more ergonomic feel. U-WAVE-Fit is the same technology as the U-WAVE-T, just a smaller version.

**UP TO
10%
OFF**

U-WAVE fit

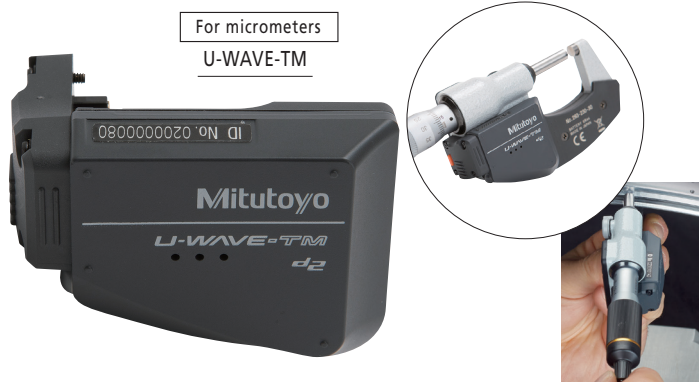

U-WAVE-TM for micrometers and U-WAVE-TC for calipers are available both as the buzzer and water/dust-proof IP67 types. The buzzer type notifies the normal reception of data by LED and buzzer sound. The water/dust-proof IP67 type is designed for harsh environments and therefore is only equipped with LED notification of data reception.

MeasurLink ENABLED
Data Management Software by Mitutoyo

U-WAVE-Fit (Transmitter)

Order No.	Model	Measuring Instrument*	Remarks	List	Promo
264-620-IP-S	U-WAVE-TC	4", 6", 8", 12" IP67 standard caliper	Transmitter and Connection Unit	\$409.00	\$368.10
264-620-IP	U-WAVE-TC	4", 6", 8", 12" IP67 caliper	Transmitter and Connection Unit	\$409.00	\$368.10
264-622-IP-M	U-WAVE-TM	Coolant-proof (IP65) micrometer Micrometers (excl. S1, excl. QuickMike)	Transmitter and Connection Unit	\$409.00	\$368.10
02AZF700-TM	U-WAVE-TM	0.5" (12.5mm) Stroke for S1 Indicators	Transmitter and Connection Unit	\$434.00	\$390.60
02AZG011-TM	U-WAVE-TM	1" (25.4mm) Stroke or Larger for S1 Indicators	Transmitter, Bracket, and Connection Unit	\$509.00	\$458.10

* Please contact Mitutoyo or distributor for further details

- The transmitter is designed to fit in the space behind the display, and the connecting cable has been replaced by a rigid connector.
- Approx. 20 m transmission range (within visible range).
- 2.4GHz wireless system for reliable and secure data transmission.
- Easy data export to Microsoft® Excel® or SPC software applications.
- Transmitter confirms data transfer by an LED signal and optional buzzer.
- An IP67 transmitter is available to ensure a coolant-proof gaging system.
- Low power consumption: 400,000 data transmissions with a single battery.

U-WAVE-R (Receiver)

Order No.	Remarks	Software	Number of U-WAVE-R units that can be connected to PC	Number of U-WAVE-T units that can be connected	List	Promo
02AZD810D	U-WAVE-R + Software	U-WAVE PAK	Up to 15	Up to 100	\$717.00	\$645.30

MeasurLink® Quality Data Management Software

Monitor, analyze, collect, calibrate, report and improve.

**15%
OFF**

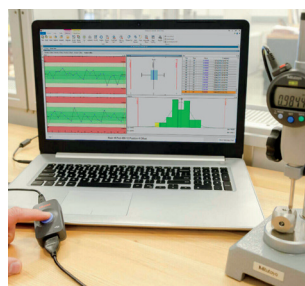

Achieve Total Quality Management with the Total Quality MeasurLink® license. This is a single floating license that can be accessed by anyone and anywhere on the network with every single module. For the engineer(s) who wants total freedom to continuously improve their quality department. **No annual fees.**

Order No.	Remarks	List	Promo
64AAB855F	MeasurLink® V10 Single Floating License	\$3,887.50	\$3,290.00

TQM License Includes:

- > Real-Time SPC
- > AQL Sampling
- > Advanced Data Analysis
- > Automated Reporting and Analysis
- > Data Collection Alerts
- > Gage Inventory Management
- > Gage Calibration
- > Gage R&R
- > Automated Ballooning
- > AS9102 First Article Reports
- > And more!

All prices are in Canadian Dollars

Solution for Battery Foil Thickness Measurement

The key to success:

High accuracy thickness measurement of thin foil and film samples

- > The combination of the Litematic and the vacuum plate system provides high accuracy measurement of easily deformed material.
- > Litematics allow measurements at forces as low as 0.01N. The ceramic ball contact included with the Vacuum Packages will increase the force to 0.04N.
- > The vacuum plate absorbs the contact-sensitive specimen, such as battery film, onto the plate surface for more stable measurement.
- > Mitutoyo America provides vacuum plate packages as well as custom-made solutions.
- > Optional set O2AZE375 enables the application of up to 10 intermediate forces.
- > Data export to MeasurLink® and MS Excel®.

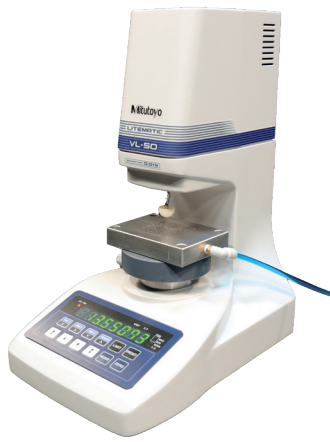
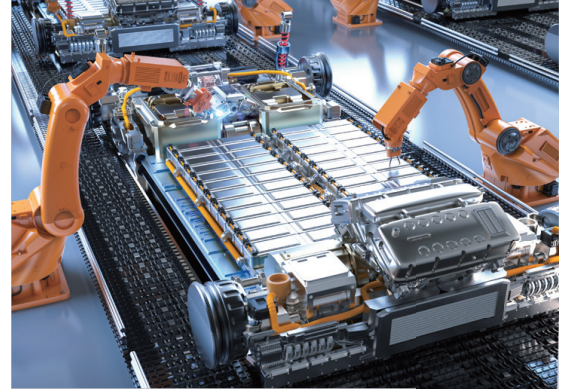

318-221A + 64PKA297



318-221A + K543722



318-226A + 64PKA298 + 957460



Stand-alone Litematic Main Unit

Code	Model	Test Force*	List	Promo
318-221A	VL-50-B	0.01N	\$12,088.00	\$11,484.00

> Measuring accuracy (20°C) up to $(0.5+L/100)$ μm L=arbitrary measuring length (mm).

> Repeatability up to 0.05 μm .

*The ceramic ball contact included with Vacuum Packages will add 0.03N.



Vacuum Package Add-ons

Code	Model	List	Promo
64PKA297	50x50mm Vacuum Package	\$5,086.41	-
K543722	Laser-activated Vacuum Package	\$17,620.97	\$14,978.00



Separate Type Litematic Main Unit

Code	Model	Test Force*	List	Promo
318-226A	VL-50S-B	0.01N	\$12,088.00	\$11,484.00
957460	Granite Stand		\$6,230.00	\$5,919.00

> Measuring accuracy (20°C) up to $(0.5+L/100)$ μm L=arbitrary measuring length (mm).

> Repeatability up to 0.05 μm .

*The ceramic ball contact included with Vacuum Packages will add 0.03N.



Vacuum Package Add-ons

Code	Model	List	Promo
64PKA298	100x100mm Vacuum Package	\$5,598.91	-

All prices are in Canadian Dollars

EJ Series Industrial Interface-mounted Compact Counter

Compact size and easy to use

Up to 8 compact counters (EJ counters) can be linked providing the capacity to connect up to 16 gages. On a DIN rail, each unit can be connected directly without using cables, so it takes up minimal space. All linked units and gages can be driven by a single power source.

EtherNet/IP, CC-Link, PROFINET, EtherCAT or USB Connection

Data can be output through an industrial interface by linking a compact counter (EJ counter) with an interface unit. Constant data monitoring and positional management are performed. A USB interface is also provided for easy connection with a computer.

Note: The range of interfaces is set to be expanded in the near future.

Calculation function

Enables sum difference operations between 2 gages connected to the same counter. Functions such as tolerance judgment and peak hold are also included.



Order No	Description	List	Promo
542-081	Main EJ Module Counter	\$755.00	\$732.00
542-081A	Main EJ Module w/AC Components	\$790.00	\$766.00
21HZA149	USB Only Interface	\$514.00	\$499.00
21HZA186	CC-Link Module (Mitsubishi), and USB	\$1,112.00	\$1,079.00
21HZA187	PROFINET Module	\$1,280.00	\$1,242.00
21HZA188	EtherNet/IP Module	\$1,266.00	\$1,228.00
21HZA264	EtherCat Module	\$1,313.00	\$1,274.00

Linear Gage LG100 Series

542-190/542-191/542-192
(10 mm stroke)



542-193/542-194/542-195
(25 mm stroke)



542-196/542-197
(50 mm stroke)



Order No	Description	List	Promo
542-190	LG100-110, Range: .4"/10mm, Res: .00005"/1µm	\$863.00	\$837.00
542-193	LG100-125, Range: 1"/25mm, Res: .00005"/1µm	\$1,070.00	\$1,038.00
542-196	LG100-150, Range: 2"/50mm, Res: .00005"/1µm	\$1,276.00	\$1,238.00
542-191	LG100-0510, Range: .4"/10mm, Res: .00002"/0.5µm	\$889.00	\$862.00
542-194	LG100-0525, Range: 1"/25mm, Res: .00002"/0.5µm	\$1,142.00	\$1,108.00
542-197	LG100-0550, Range: 2"/50mm, Res: .00002"/0.5µm	\$1,314.00	\$1,275.00
542-192	LG100-0110, Range: .4"/10mm, Res: 5µinch/0.1µm	\$1,329.00	\$1,130.00
542-195	LG100-0125, Range: 1"/25mm, Res: 5µinch/0.1µm	\$1,100.00	\$1,067.00

High accuracy

Precision and accuracy demanded by the automated assembly and inspection markets are guaranteed. Due to our expertise as a manufacturer of measuring instruments, repeatability in the full measurement range (2σ) and narrow-range precision are also guaranteed.

Environment resistance

Sliding durability of more than 50 million cycles*, with protection level of IP67G. A highly oil-resistant material is used in the rubber cap and cable sheath so it can be used in harsh environments.

* 10 mm range models (Actual value from in-house tests)

Reference point detection (LG100 Series)

Reference point signal output functions are featured throughout this series. When incorporating into a device, the master setting value is easy to set and is retained after shutdown.

LG QuickSetup Tool

A configuration tool is FREE for use with the EJ counter when connected via the optional USB interface. Multiple settings normally carried out with counter operating keys can now be easily applied from a computer. Live displays allow for easily viewing gage positions or measurements at a glance.

Note: This software can be used free of charge and downloaded from the Mitutoyo website.
<https://www.mitutoyo.co.jp/eng/contact/products/lg/>

Linear Gage LG200 Series

542-186/542-187/542-188



Order No	Description	List	Promo
542-188	LG200-0110, Range: 0.4"/10mm, Res: .00005"/0.1µm	\$1,177.00	\$1,142.00
542-187	LG200-0510, Range: 0.4"/10mm, Res: .00002"/0.5µm	\$1,018.00	\$987.00
542-186	LG200-110, Range: 0.4"/10mm, Res: .00005"/1µm	\$1,018.00	\$987.00

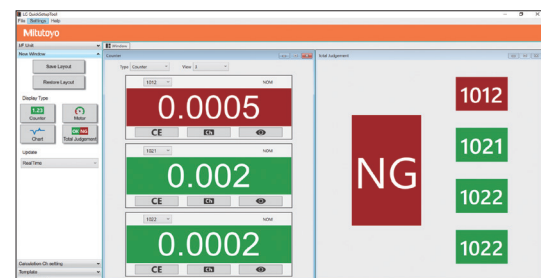

All prices are in Canadian Dollars

Digimatic Quill Kit

Easy Installation, Fits Most Vertical Knee Mills

- > Easy-to-read LCD with resolution of .0005"/0.01mm. 0-6" travel.
- > Push-button controls for inch/mm, Zero-Set and On/Off.
- > Powered by a single SR-44 Battery which lasts about 1 year with normal use.
- > SPC Output for data transmission to data processors or a remote display.
- > ABS encoder.

Order No.	Description	List	Promo
053906B	Digimatic Quill Kit Complete with Brackets & Scale for Bridgeport Type Machines	\$434.00	\$421.00

SPC
ABSOLUTE™

MeasurLink™ ENABLED
Data Management Software by Mitutoyo

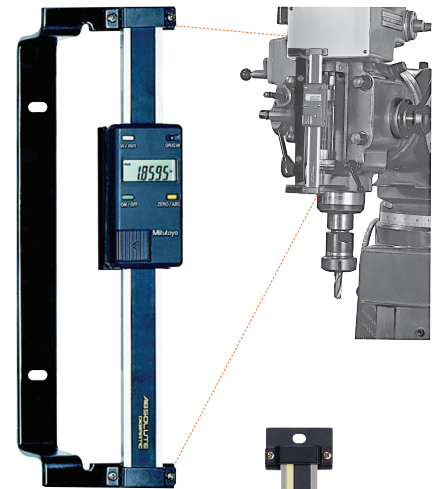

ABSOLUTE Digimatic Scale Units

- > The Origin key allows setting of an ABSOLUTE zero point to be used as reference in subsequent measurements. Once set, the ABS Digimatic Scale Unit is ready to show its true position whenever turned on, rather than 0.00" as with standard models.
- > The Zero/ABS key allows the display to be zero-set at any slider position along the beam for incremental comparison measurements. This key will also allow return to the ABSOLUTE coordinate with a display of the true position from the origin point.
- > No rack, no pinion, no glass scale. Digimatic scale unit is safely embedded in the hardened stainless steel blade.
- > Horizontal or vertical face according to the scale mounting direction.
- > Multi-function types with diameter displaying function are also available for lathes. (Contact Mitutoyo.)
- > All units come with two mounting brackets, each located at either end of the scale.
- > With SPC data output.

SPC
ABSOLUTE™



MeasurLink™ ENABLED
Data Management Software by Mitutoyo

Order No	Model	Range	Accuracy	Resolution	Type	List	Promo
572-210-30	SD-4"D	0-4" / 0-100mm	.001" / 0.03mm	.0005" / 0.01mm	Horizontal Single-function	\$331.00	\$321.00
572-211-30	SD-6"D	0-6" / 0-150mm	.001" / 0.03mm	.0005" / 0.01mm	Horizontal Single-function	\$350.00	\$333.00
572-212-30	SD-8"D	0-8" / 0-200mm	.001" / 0.03mm	.0005" / 0.01mm	Horizontal Single-function	\$398.00	\$386.00
572-213-10	SD-12"D	0-12" / 0-300mm	.002" / 0.04mm	.0005" / 0.01mm	Horizontal Single-function	\$769.00	\$654.00
572-310-10	SDV-6"D	0-4" / 0-100mm	.001" / 0.03mm	.0005" / 0.01mm	Vertical Single-function	\$367.00	\$349.00
572-311-10	SDV-6"D	0-6" / 0-150mm	.001" / 0.03mm	.0005" / 0.01mm	Vertical Single-function	\$389.00	\$370.00
572-312-10	SDV-8"D	0-8" / 0-200mm	.001" / 0.03mm	.0005" / 0.01mm	Vertical Single-function	\$451.00	\$383.00
572-313-10	SDV-12"D	0-12" / 0-300mm	.002" / 0.04mm	.0005" / 0.01mm	Vertical Single-function	\$868.00	\$738.00

Applications

Machine table position

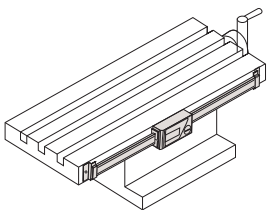

Drilling machine stroke position

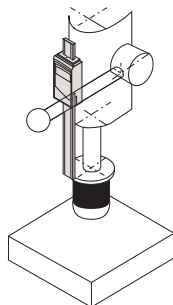

Focus setting on optical instruments

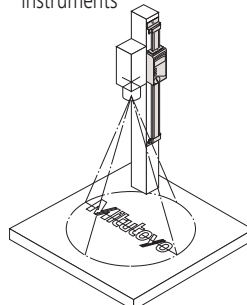

Special Applications

As a measurement jig for outdoor use (SD-G)

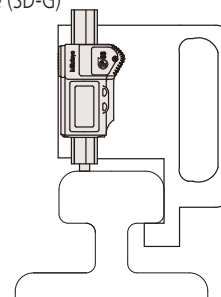

Detector head mechanism

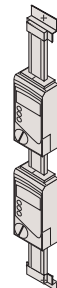

Linear Encoders for Lathes, Grinders, and Mills

Mitutoyo Digital Readout Packages

Mounting hardware included on all machine retrofit packages

SAVE
\$200
PER PACKAGE



All DRO Packages Include:

- > KA-200 Counter
- > KA-200 Counter tray/arm kit
- > High Resolution Linear Scales (down to .0001" or better!)
- > Bracket Kit(s)

MeasurLink ENABLED
Data Management Software by Mitutoyo

Package Part No.	Description	X Travel	Y Travel	Z Travel	X Axis Type	Y Axis Type	Z Axis Type	List	Promo
64PKA058D	12" X 30" DRO Mill Package	30"	12"	-	AT715	AT715	-	\$2,303.00	\$2,103.00
64PKA059D	12" X 36" DRO Mill Package	36"	12"	-	AT715	AT715	-	\$2,341.50	\$2,141.50
64PKA060C	14" X 30" DRO Mill Package	30"	14"	-	AT715	AT715	-	\$2,201.00	\$2,001.00
64PKA175B	16" X 30" DRO Mill Package	30"	16"	-	AT715	AT715	-	\$2,314.00	\$2,114.00
64PKA062D	16" X 36" DRO Mill Package	36"	16"	-	AT715	AT715	-	\$2,353.00	\$2,153.00
64PKA063C	16" X 40" DRO Mill Package	40"	16"	-	AT715	AT715	-	\$2,380.00	\$2,180.00
64PKA039C	8" X 40" Lathe Package	8"	-	40"	AT113	-	AT715	\$2,508.00	\$2,308.00
64PKA194B	8" X 36" Lathe Package	8"	-	36"	AT113	-	AT715	\$2,482.00	\$2,282.00
64PKA054A	48" X 14" Lathe Package	14"	-	48"	AT116	-	AT715	\$2,075.00	\$1,875.00
64PKA052B	14" X 40" Lathe Package	14"	-	40"	AT116	-	AT715	\$2,310.00	\$2,110.00
64PKA057B	16" X 60" Lathe Package	16"	-	60"	AT116	-	AT715	\$2,875.00	\$2,675.00
64PKA026B	6" X 12" Grinder Package	6"	12"	-	AT113	AT113	-	\$3,301.00	\$3,101.00
64PKA028C	8" X 12" Grinder Package	8"	12"	-	AT113	AT113	-	\$3,362.00	\$3,162.00
64PKA029B	8" X 14" Grinder Package	12"	14"	-	AT113	AT113	-	\$3,406.00	\$3,206.00

Other packages and kits are available for mills, lathes, grinders and custom machines and applications. Contact your local distributor for details.

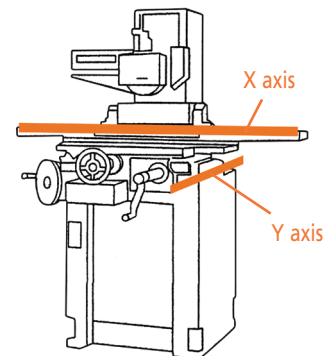
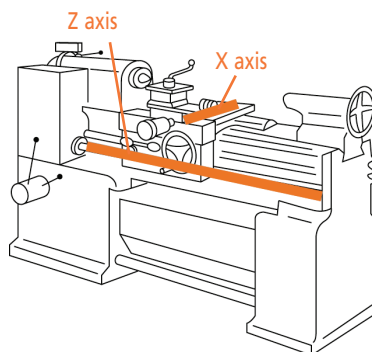
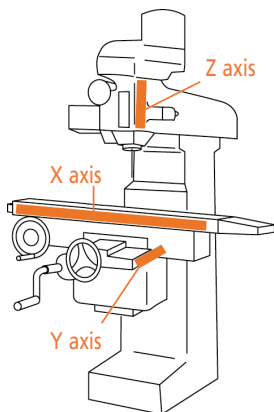

All prices are in Canadian Dollars

Rockwell and Rockwell Superficial Hardness Tester

With Real-Time Electronic Test Force Control

- › Closed-loop control of testing forces.
- › Initial and Total test forces (loads) are applied with unparalleled accuracy and repeatability.
- › Extended indenter arm reaches inside diameters and hard-to-reach surfaces at eye level, allowing the operator to easily see where the indenter accesses small or hard-to-reach parts.
- › Automatic cycle start after initial set point is reached.
- › Continuous test mode for automatic testing of all like-sized parts.
- › All hardness parameters set automatically via the touch screen.
- › Cylindrical and spherical surface corrections.
- › Auto conversion to most common hardness scales or tensile strength.

MeasurLink ENABLED
Data Management Software by Mitutoyo

Model No.	HR-530	HR-530L	
Order No.	810-233-33	810-333-33	
Hardness testing methods	Rockwell / Rockwell Superficial / Brinell / Plastics Hardness		
Initial Test Force	29.42 N (3kgf), 98.07 N (10kgf)		
Test Force (N)	Superficial	147.1 N (15kgf), 294.2 N (30kgf), 441.3 M (45kgf)	
	Rockwell	588.4 N (60kgf), 980.7 N (100kgf), 1471 N (150kgf)	
Test Force (N)	Light Force Brinell	61.29 N (6.25kgf), 98.07 N (10kgf), 153.2 N (15.625kgf), 245.2 N (25kgf), 294.2 N (30kgf), 306.5 N (31.25kgf), 612.9 N (62.5kgf), 980.7 N (100kgf), 1226 N (125kgf), 1839 N (187.5kgf)	
	Test Force Control	Automatic (load / hold / unload)	
Maximum Specimen Size	Height: 9.8" (250mm) Depth: 5.9" (150mm)	Height: 15.5" (395mm) Depth: 5.9" (150mm)	
External Data Output	RS-232C, Digimatic, USB2.0		
External Dimensions	Main Unit	9.84" x 26.38" x 23.82" (250 w x 667 d x 621 h mm)	11.6" x 26.2" x 30.1" (300 w x 667 d x 766 h mm)
	Touch-Panel Display	191 w x 147 d x 71 h mm (Color)	
Mass	Approx. 60 kg	Approx. 69 kg	
List	\$20,901.00	\$28,788.48	
Promo	\$19,000.00	\$26,198.00	

* Must purchase Power Cord **02ZAA010**

10% OFF 10% off all Packages

FREE SHIPPING Free Shipping

Installation & Calibration Included

HR-530
810-233-33

10% OFF 10% off all Packages

FREE SHIPPING Free Shipping

Installation & Calibration Included

HR-530L
810-333-33

ASTM Compliant HR Series Rockwell and Superficial Hardness Tester Packages Include:

- › Certified Blocks and Indenters
- › C and N Scale Indenter
- › 1/16" Carbide Ball Indenter
- › HRC30 Rockwell Test Block
- › HRC63 Rockwell Test Block
- › HRBW95 Rockwell Test Block
- › HR30N60 Rockwell Test Block
- › HR30TW70 Rockwell Test Block
- › Certificate stating conformance to ASTM E 18
- › Mitutoyo Installation and A2LA Calibration



HR-430MR includes only diamond indenter, C-scale indenter, HRC and HRBW blocks listed above

Calibration Set

Order No.	Order No.	Order No.	Order No.
64HAA462	64HAA463	64HAA464	64HAA465
HRC Scale	HRBW Scale	HR30N Scale	HR30TW Scale
Test Blocks	Test Blocks	Test Blocks	Test Blocks
64HAA181	64HAA172	64HAA270	64HAA303
64HAA177	64HAA170	64HAA266	64HAA301
64HAA173	64HAA168	64HAA262	64HAA299
Universal Style Indenter with Flat			
64HAA100	64HAA119	64HAA101	64HAA119



For more information regarding compatible accessories such as fixtures, indenters, and calibration blocks use the QR Code!





SCAN ME

A Complete Line of ASTM Compliant Rockwell Hardness Testing Machines

10% OFF 10% off all Packages

FREE SHIPPING Free Shipping

Installation & Calibration Included



	HR-320MS	HR-430MR	HR-430MS	HR-530/HR-530L	HR-610A/HR-620A	HR-620B
Rockwell Scales		X				
Rockwell and Superficial	X		X	X	X	X
Dead Weight	X	X	X			
Individual Hanging Weights	X					
Dial Weight		X	X			
Automatic break		X	X			
Closed Loop				X	X	X
Digital Display	X	X	X	X	X	X
7.1" Max Sample Height	X	X	X			
9.8" Max Sample Height				HR-530	X	X
15.5" Max Sample Height				HR-530L		
6.5" Max Depth	X	X	X			
5.9" Max Depth						
8.6" Max Depth				X	X	X
CNC						X
Motorized X Stage (Optional)					X	X
Motorized Y Stage						X
Software Control and Analysis						X
ASTM Compliant HR Series Rockwell & Rockwell Superficial Packages - All 10% Off	810-192-21	810-193-21	810-194-31	810-233-33 (HR530) or 810-333-33 (HR530L)	810-512-23 (HR610A) or 810-522-23 (HR620A)	810-527-21
List	\$12,622.00	\$14,126.00	\$18,580.32	\$20,901.00 / \$28,788.48	\$39,196.00 / \$42,453.00	\$70,791.00
Promo	\$11,359.80	\$12,713.40	\$16,722.29	\$19,000.00 / \$26,198.00	\$35,276.40 / \$38,207.70	\$63,711.90

* Must purchase Power Cord 022AA010

Scalable Interfacing Options



HR-320MS, HR-430MR, HR-430MS Interface



HR-530, HR-530L, HR-610A & HR-620A Touchscreen Controller



HR-620B PC Interface, Utilizing AVPAK Software

All prices are in Canadian Dollars

Heavy Load Hardness Testers - HV Series

Highly Versatile Basic Model

HV-110/120 System A

- > Equipped with a high performance motorized test force selection function and motorized turret mounts.
- > Operates as smoothly as electric models but with the certainty of traditional test forces.
- > A list function makes it easy to perform multi-point and average hardness evaluations which required extra effort or external data processors with conventional manual models. This convenient screen enables consistency of test results.
- > Motorized test force selection and motorized turret positions can be easily controlled via a touch screen control panel. Adjustable X-Y stage with built-in digital micrometers for detailed measurement analysis.



Model	Test Force									Order No.	Body	List	Promo		
HV-110	V.S*	HV1	HV2	HV3	HV4	HV5	HV10	HV20	HV50	810-440-13	A TYPE	Request a Quote			
	N	9.807	19.61	29.52	49.03	98.07	196.10	294.2	490.3						
	kgf	1	2	3	5	10	20	30	50						
HV-120	V.S*	HV 0.3	HV 0.5	HV1	HV2.5	HV5	HV10	HV20	HV30	810-445-13	A TYPE			Request a Quote	
	N	2.942	4.903	9.807	24.51	49.03	98.07	196.1	294.2						
	kgf	0.3	0.5	1	2.5	5	10	20	30						

*V.S - Vickers Scale

*Additional Components Required for a Complete System

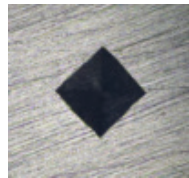
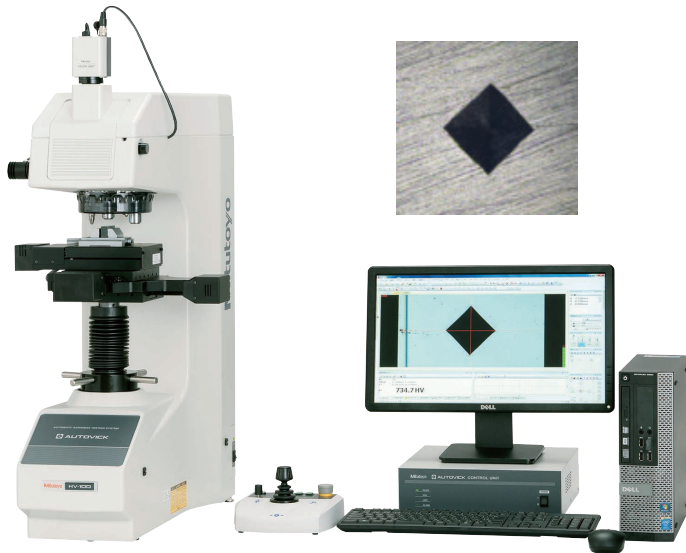

Advanced models promise additional productivity improvements

HV-110/120 System B,D

- > B and D series testers feature AVPAK dedicated image software enabling automatic indentation reading with excellent automatic edge detection capability, reducing reading variation and visual error.
- > D series testers add powered X-Y stages which enable automatic continuous testing. This allows extended multi-point testing, complex pattern creation and multiple workpiece analysis to be carried out automatically.
- > D series testers add Auto Focus and create a fully automatic system that dramatically shortens the cycle time of your test and indentation analysis!

Model	Test Force									Order No.	Body	List	Promo		
HV-110	V.S*	HV1	HV2	HV3	HV4	HV5	HV10	HV20	HV50	810-443A	B / D TYPE	Request a Quote			
	N	9.807	19.61	29.52	49.03	98.07	196.10	294.2	490.3						
	kgf	1	2	3	5	10	20	30	50						
HV-120	V.S*	HV 0.3	HV 0.5	HV1	HV2.5	HV5	HV10	HV20	HV30	810-448A	B / D TYPE			Request a Quote	
	N	2.942	4.903	9.807	24.51	49.03	98.07	196.1	294.2						
	kgf	0.3	0.5	1	2.5	5	10	20	30						

*V.S - Vickers Scale

*Additional Components Required for a Complete System



SCAN ME

Micro Vickers Hardness Testers - HM Series

- > HM Type A systems include a built-in measuring eyepiece for indentation analysis and accurate workpiece positioning.
- > Automatic Turret (Touch-screen controlled in Type A systems and software controlled via AVPAK in Type B and D systems).
- > Test force range 10g-1000g (HM-210) and .05-2000g (HM-220).
- > LED illumination.
- > Type B and D systems include a camera for software analysis (Type A systems can use optional camera for digital imagery).
- > Type A and B systems use micrometer-controlled adjustable stages and Type D systems utilize a motorized XY Stage.

20% OFF 20% off all Packages

FREE SHIPPING Free Shipping

Installation & Calibration Included



64AAB305PA HM-210A

MeasurLink ENABLED
Data Management Software by Mitutoyo

Seamless assistance is a scan away - Connect with your local representative by making an inquiry today!



SCAN ME

20% OFF MICRO VICKERS TESTERS!

Functions	System A	System B	System D
Focusing	Manual	Manual	Automatic
Testing Action	Single Point	Single Point	Pattern Specific
Test-point Positioning	Manual X-Y Stage	Manual X-Y Stage	Automatic X-Y Stage
Measuring Indentations	Manual Monoscope	Automatic by AVPAK	Automatic by AVPAK
Camera (for observing and measuring indentations)	600,000 Pixels B&W*	Color, 3 Million Pixels	Color, 3 Million Pixels
Operating the Main Unit	Touch Panel	PC**	PC**
Order No	64AAB305PA	64AAB323PA	64AAB380PA
Main Unit	HM-210A	HM-210B	HM210D
List	Request a Quote		
Promo			

** PC sold separately

*Additional packages available. Please contact your local Mitutoyo distributor or Mitutoyo sales representative.

Portable Hardness Testers

Durometers (Digital and Analog)

For Rubber and Plastic Hardness Testing



Compact Dial 811-335-10



Compact Digital 811-336-10



MeasurLink ENABLED
Data Management Software by Mitutoyo

Order No	Model	Scale	Display	Graduation	Range	Indenter	List	Promo
811-335-10	HH-335	Shore A	Analog	1.0	10~90	Blunt Taper	\$854.00	\$768.60
811-336-10	HH-336	Shore A	Digital	0.5	10~90	Blunt Taper	\$1,825.00	\$1,642.50
811-337-10	HH-337	Shore D	Analog	1.0	20~90	Sharp Point	\$854.00	\$768.60
811-338-10	HH-338	Shore D	Digital	0.5	20~90	Sharp Point	\$1,825.00	\$1,642.50

HH-411 Hardmatic

Rebound Leeb portable hardness tester featuring reproducibility and ease of operation on large parts. It is lightweight and can be carried into the shop or out in the field.

Order No.	Type	List	Promo
810-298-10	HH-411 Hardmatic	\$5,695.00	\$5,410.00

MeasurLink ENABLED
Data Management Software by Mitutoyo



All prices are in Canadian Dollars

MF Measuring Microscopes with Metlogix M2 Software and Touch-Screen Tablet

Featuring M2 geometric measuring display

- Highest measuring accuracy in its class.
- Stage travel range up to 400mm x 200mm / 16in x 8in.
- Quick release mechanism and zero-set buttons on stage controls increase operability when working on larger workpieces.
- Easy-to-use all-in-one PC Touch Screen Display.
- M2 Geometric 2D Measurement Software.
- Camera port is standard on all models.
- Wide range of objectives available from 1x to 100x.
- M2 Retrofit package available for D generation MF and MF-U microscopes.
- Microscope packages with M2 software and tablet are listed below.



172-864-10 - MF-A3017, LED, BINOCULAR TUBE, 64PKA234A - M2 SYSTEM

Main Units on Promotion

Order No	Description	List	Promo
176-961-13	MF-A1010D 100x100mm (mm/inch) Manual Microscope	Request a Quote	
176-962-13	MF-A2010D 200x100mm (mm/inch) Manual Microscope		
176-963-13	MF-A2017D 200x170mm (mm/inch) Manual Microscope		
176-864-10	MF-A3017D 300x170mm (mm/inch) Manual Microscope		
176-965-13	MF-A4017D 400x200mm (mm/inch) Manual Microscope		
64PKA234A	M2 Retrofit Kit for MF/MF-U Microscopes		

*Additional stage configurations and sizes available

MeasurLink ENABLED
Data Management Software by Mitutoyo

Want to take a closer look?
Scan the QR code to make your product inquiry today!



SCAN ME

MF-U Measuring Microscopes

- Measuring accuracy that is highest in its class (and conforms to JIS B 7153).
- Compatible with both brightfield and darkfield objective lenses.
- Manual or motorized turrets available dependent on model.
- Compatible with M2 retrofit Kit.



176-872-10 MF-UA2010 - with 64PKA234A M2 Software/Hardware

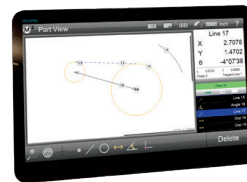

MeasurLink ENABLED
Data Management Software by Mitutoyo

To learn more about our MF and MF-U Microscopes please visit our webpage.



SCAN ME

Model No. (XY stage size)	MF-UA2010D
Order No.	176-872-10
XY stage travel range	8 x 4" / 200 x 100mm
Z-axis travel range	6" / 150mm
Focusing method	Manual focusing (Coarse focusing: 30mm/rev., Fine focusing: 0.2mm/rev.)
Measurement method	Linear encoder (2-axis model: X / Y-axis)
Resolution (switchable)	.0001" / .00005" / .00001" (0.001mm / 0.0005mm / 0.0001mm)
Measuring accuracy (at 20°C)	XY-axis: (2.2+0.02L)µm, L = Measuring length (mm) when not loaded, JIS B 7153
Floating function	X and Y axes with Quick-release mechanism
XY stage top size	13.78 x 11.02" / 350 x 280 mm
Effective glass size	9.84 x 5.09" / 250 x 150 mm
Max. stage loading	22lbs / 10kg
Max. workpiece height	6" / 150mm
List	Request a Quote
Promo	

*Additional components required for a complete system

TM Toolmakers' Microscopes

- > Adjustable illumination intensity.
- > Angle measurement is performed easily by turning the angle scale disc to align the cross-hair reticle with the workpiece image.
- > Includes standard accessories which create an overall magnification of 30X. Magnifications can be changed from 20X - 200X by using optional objectives and/or eyepieces.
- > .000050" Resolution Digimatic micrometer heads included.

MeasurLink ENABLED
Data Management Software by Mitutoyo

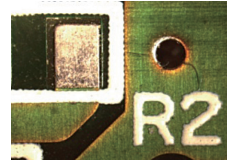

Newly designed LED illumination

10% OFF

TM-A505B
176-820A



Model No.	TM-A505B	TM-A1005B
Order No.	176-820-11A	176-821-11A
Eyepiece	Standard accessory: 15X (field number: 13), Options: 10X, 20X	
Objective lens	Standard accessory: 2X, Options: 5X, 10X	
Microscope head	Maximum height of workpiece 4.53" / 115mm	4.21" / 107mm
Illumination unit	Transmitted illumination	Stepless brightness adjustment, White LED light source, with green filter
	Surface illumination	Oblique single-source type, Stepless brightness adjustment, White LED light source
Cross-travel stage	Measuring range	4" x 2" / 100x50mm (An optional 2"/50mm gage block is required to cover full range. A CERA block is recommended.)
	Usable area of the stage glass	2" x 2" / 50x50mm
	Maximum stage glass loading	3.8" x 3.8" / 96x96mm
Linear measurement method	11 lbs. / 5kg	
List	\$7,969.00	\$10,392.00
Promo	\$7,172.10	\$9,352.80



Order No.	Description
64PPI247	MOTICAM S1, 1.2 MEGAPIXEL-1/3" CMOS, USB
64PPI249	MOTICAM S3, 3.0 MEGAPIXEL-1/2" CMOS, USB
64PPI248	MOTICAM S6, 6.0 MEGAPIXEL-1/1.8" CMOS, USB
64PPI252	MOTI-CAM 4000, 8 MEGAPIXEL, 1/1.8" CMOS, USB/HDMI
63AAA060	.37x C-Mount Eyetube Adapter

Trinocular Stereo Microscope SMZ143-N2LED

- > Continuous 1X - 4X magnification.
- > Image always in focus throughout zoom range.
- > Crisp, erect images with high resolution and excellent stereoscopic effect.
- > Stereo-tube can be rotated a full 360° for viewing at any angle.
- > Bilateral zoom control knob adds convenience and increases operator efficiency.
- > Diopter adjustment for both eyepieces.

Model	MSM-414TL
Order No.	377-993A
Optical tube	Trinocular head
Total magnification	10X - 40X
Eyepiece	Widefield WF10X/20mm
Objective	1X - 4X
Working distance	80mm
Field of view	20mm - 5mm
Dimensions	237x170x335mm
Mass	6.2kg

10% OFF



Camera with software for digital viewing

Order No.	Description	List	Promo
Stereo Microscope Unit			
377-993A	MSM-414TL TRINOCULAR MICROSCOPE	Request a Quote	
Observational Camera Accessories			
377-481	C-mount Video Adapter for SMZ143-N2LED	\$76.00	\$68.40
64PPI309	MOTICAM 4000X, 1.45 x 1.45µm PIXEL, HDMI / USB MULTIPOINT	\$3,100.00	\$2,790.00

*377-481 and 64PPI252 purchased separately

ALWAYS THERE. ALWAYS READY.

YOUR DEDICATED SUCCESS TEAM

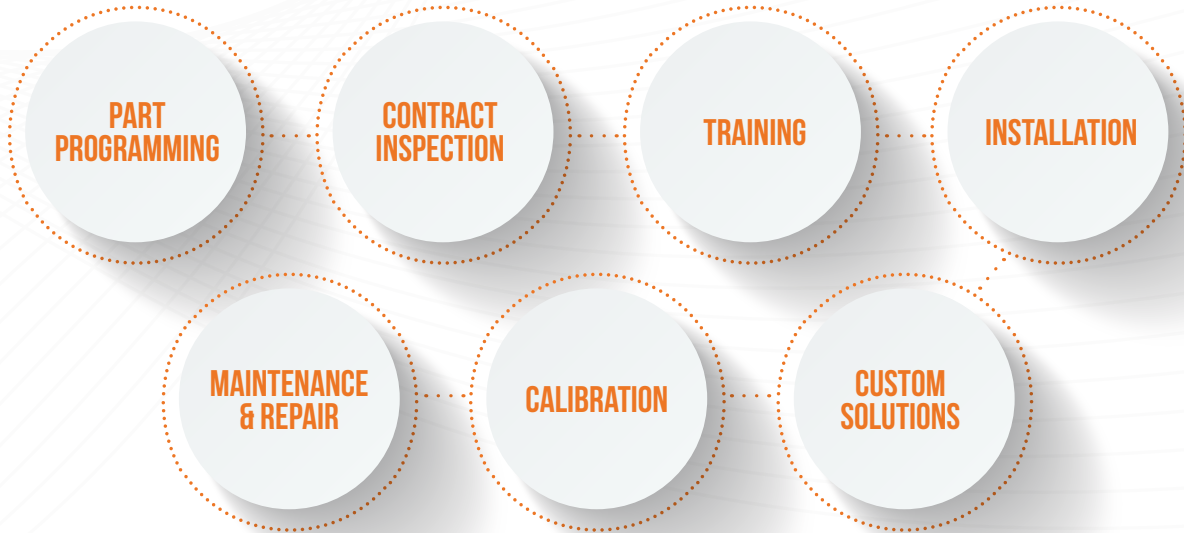

SCAN ME

Scan the QR Code
to learn more about
the training we
have to offer

Mississauga ON
2121 Meadowvale Blvd.,
Mississauga, ON L5N 5N1
Tel. (905) 821-1261

Montréal QC
#129-7075 place Robert-Joncas,
Montréal, QC H4M 2Z2
Tel. (514) 337-5994 Ext. 251

Total Number of Employees: Approximately 100

Mitutoyo products are sold through authorized distributors which can be found at www.mitutoyo.ca/find-a-distributor/

We reserve the right to change prices and specifications without notice. Visit mitutoyo.ca/promotions to ensure pricing is up to date. Not valid with any other offer or promotion. This promotion is for Canadian market only. Request formal quotation for complete details.

Note: All information regarding our products, and in particular the illustrations, drawings, dimensional and performance data contained in this printed matter as well as other technical data are to be regarded as approximate average values. We reserve the right to make changes to the corresponding designs. The stated standards, technical regulations, descriptions and illustrations of the products were valid at the time of printing. In addition, the products are subject to Canadian Export Administration Regulations. Re-export or relocation of Mitutoyo products may require prior approval by an appropriate governing authority. We try to be as accurate as possible, however, there may be some errors in text, specifications or price. Please confirm with your customer service rep. Some items may not be exactly as shown. Prices are in Canadian dollars, unless otherwise specified. Applicable taxes and shipping charges are extra.

Mitutoyo

Mitutoyo Canada | Precision is our Profession

**EXPERIENCE MITUTOYO
M3 SOLUTION CENTERS**

30M 0225 • Printed in USA • April 2025